

# Osteosynthese

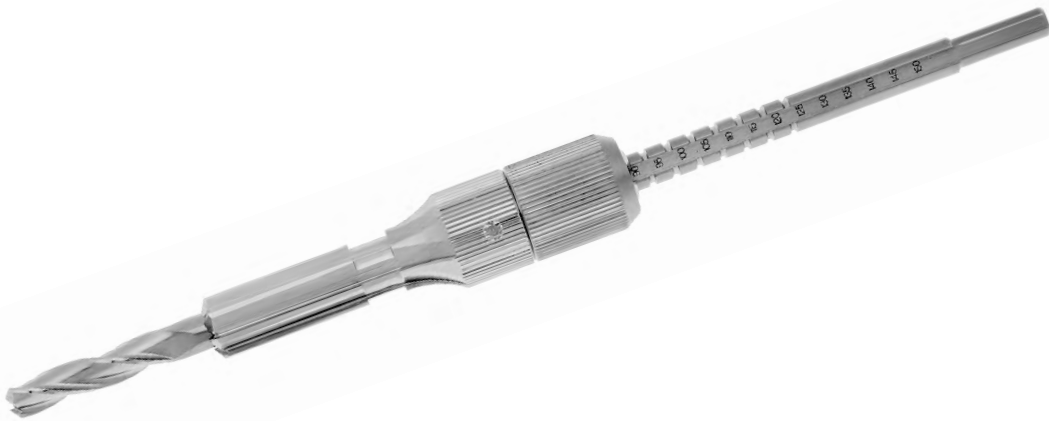





**Knochen Nagelung**  
**Bone Nailing**  
**Enclavamiento de hueso**

# Knochennagelung

## Bone Nailing

### Enclavamiento de hueso

#### Küntscher Nagel für Oberschenkel mit einem Loch

#### Küntscher Medullary Nail for Femur single slot

#### Clavo de Küntscher intramedular para Femur con un agujero



Dia Length	6 mm	7 mm	8 mm	9 mm	10 mm	11 mm	12 mm	13 mm	14 mm	15 mm	16 mm	17 mm	18 mm
14 cm	80-106-14	80-107-14	80-108-14	80-109-14	80-110-14	80-111-14	80-112-14	80-113-14	80-114-14	80-115-14	80-116-14	80-117-14	80-118-14
16 cm	80-106-16	80-107-16	80-108-16	80-109-16	80-110-16	80-111-16	80-112-16	80-113-16	80-114-16	80-115-16	80-116-16	80-117-16	80-118-16
18 cm	80-106-18	80-107-18	80-108-18	80-109-18	80-110-18	80-111-18	80-112-18	80-113-18	80-114-18	80-115-18	80-116-18	80-117-18	80-118-18
20 cm	80-106-20	80-107-20	80-108-20	80-109-20	80-110-20	80-111-20	80-112-20	80-113-20	80-114-20	80-115-20	80-116-20	80-117-20	80-118-20
22 cm	80-106-22	80-107-22	80-108-22	80-109-22	80-110-22	80-111-22	80-112-22	80-113-22	80-114-22	80-115-22	80-116-22	80-117-22	80-118-22
24 cm	80-106-24	80-107-24	80-108-24	80-109-24	80-110-24	80-111-24	80-112-24	80-113-24	80-114-24	80-115-24	80-116-24	80-117-24	80-118-24
26 cm	80-106-26	80-107-26	80-108-26	80-109-26	80-110-26	80-111-26	80-112-26	80-113-26	80-114-26	80-115-26	80-116-26	80-117-26	80-118-26
28 cm	80-106-28	80-107-28	80-108-28	80-109-28	80-110-28	80-111-28	80-112-28	80-113-28	80-114-28	80-115-28	80-116-28	80-117-28	80-118-28
30 cm	80-106-30	80-107-30	80-108-30	80-109-30	80-110-30	80-111-30	80-112-30	80-113-30	80-114-30	80-115-30	80-116-30	80-117-30	80-118-30
32 cm	80-106-32	80-107-32	80-108-32	80-109-32	80-110-32	80-111-32	80-112-32	80-113-32	80-114-32	80-115-32	80-116-32	80-117-32	80-118-32
34 cm	80-106-34	80-107-34	80-108-34	80-109-34	80-110-34	80-111-34	80-112-34	80-113-34	80-114-34	80-115-34	80-116-34	80-117-34	80-118-34
36 cm	80-106-36	80-107-36	80-108-36	80-109-36	80-110-36	80-111-36	80-112-36	80-113-36	80-114-36	80-115-36	80-116-36	80-117-36	80-118-36
38 cm	80-106-38	80-107-38	80-108-38	80-109-38	80-110-38	80-111-38	80-112-38	80-113-38	80-114-38	80-115-38	80-116-38	80-117-38	80-118-38
40 cm	80-106-40	80-107-40	80-108-40	80-109-40	80-110-40	80-111-40	80-112-40	80-113-40	80-114-40	80-115-40	80-116-40	80-117-40	80-118-40
42 cm	80-106-42	80-107-42	80-108-42	80-109-42	80-110-42	80-111-42	80-112-42	80-113-42	80-114-42	80-115-42	80-116-42	80-117-42	80-118-42
44 cm	80-106-44	80-107-44	80-108-44	80-109-44	80-110-44	80-111-44	80-112-44	80-113-44	80-114-44	80-115-44	80-116-44	80-117-44	80-118-44
46 cm	80-106-46	80-107-46	80-108-46	80-109-46	80-110-46	80-111-46	80-112-46	80-113-46	80-114-46	80-115-46	80-116-46	80-117-46	80-118-46
48 cm	80-106-48	80-107-48	80-108-48	80-109-48	80-110-48	80-111-48	80-112-48	80-113-48	80-114-48	80-115-48	80-116-48	80-117-48	80-118-48
50 cm	80-106-50	80-107-50	80-108-50	80-109-50	80-110-50	80-111-50	80-112-50	80-113-50	80-114-50	80-115-50	80-116-50	80-117-50	80-118-50
52 cm	80-106-52	80-107-52	80-108-52	80-109-52	80-110-52	80-111-52	80-112-52	80-113-52	80-114-52	80-115-52	80-116-52	80-117-52	80-118-52



**Küntscher Nagel für Oberschenkel mit Doppel - Loch**  
**Küntscher Medullary Nail for Femur double slot**  
**Clavo de Küntscher intramedular para Femur con doble agujero**



Dia Length	6 mm	7 mm	8 mm	9 mm	10 mm	11 mm	12 mm	13 mm	14 mm	15 mm	16 mm	17 mm	18 mm
14 cm	80-206-14	80-207-14	80-208-14	80-209-14	80-210-14	80-211-14	80-212-14	80-213-14	80-214-14	80-215-14	80-216-14	80-217-14	80-218-14
16 cm	80-206-16	80-207-16	80-208-16	80-209-16	80-210-16	80-211-16	80-212-16	80-213-16	80-214-16	80-215-16	80-216-16	80-217-16	80-218-16
18 cm	80-206-18	80-207-18	80-208-18	80-209-18	80-210-18	80-211-18	80-212-18	80-213-18	80-214-18	80-215-18	80-216-18	80-217-18	80-218-18
20 cm	80-206-20	80-207-20	80-208-20	80-209-20	80-210-20	80-211-20	80-212-20	80-213-20	80-214-20	80-215-20	80-216-20	80-217-20	80-218-20
22 cm	80-206-22	80-207-22	80-208-22	80-209-22	80-210-22	80-211-22	80-212-22	80-213-22	80-214-22	80-215-22	80-216-22	80-217-22	80-218-22
24 cm	80-206-24	80-207-24	80-208-24	80-209-24	80-210-24	80-211-24	80-212-24	80-213-24	80-214-24	80-215-24	80-216-24	80-217-24	80-218-24
26 cm	80-206-26	80-207-26	80-208-26	80-209-26	80-210-26	80-211-26	80-212-26	80-213-26	80-214-26	80-215-26	80-216-26	80-217-26	80-218-26
28 cm	80-206-28	80-207-28	80-208-28	80-209-28	80-210-28	80-211-28	80-212-28	80-213-28	80-214-28	80-215-28	80-216-28	80-217-28	80-218-28
30 cm	80-206-30	80-207-30	80-208-30	80-209-30	80-210-30	80-211-30	80-212-30	80-213-30	80-214-30	80-215-30	80-216-30	80-217-30	80-218-30
32 cm	80-206-32	80-207-32	80-208-32	80-209-32	80-210-32	80-211-32	80-212-32	80-213-32	80-214-32	80-215-32	80-216-32	80-217-32	80-218-32
34 cm	80-206-34	80-207-34	80-208-34	80-209-34	80-210-34	80-211-34	80-212-34	80-213-34	80-214-34	80-215-34	80-216-34	80-217-34	80-218-34
36 cm	80-206-36	80-207-36	80-208-36	80-209-36	80-210-36	80-211-36	80-212-36	80-213-36	80-214-36	80-215-36	80-216-36	80-217-36	80-218-36
38 cm	80-206-38	80-207-38	80-208-38	80-209-38	80-210-38	80-211-38	80-212-38	80-213-38	80-214-38	80-215-38	80-216-38	80-217-38	80-218-38
40 cm	80-206-40	80-207-40	80-208-40	80-209-40	80-210-40	80-211-40	80-212-40	80-213-40	80-214-40	80-215-40	80-216-40	80-217-40	80-218-40
42 cm	80-206-42	80-207-42	80-208-42	80-209-42	80-210-42	80-211-42	80-212-42	80-213-42	80-214-42	80-215-42	80-216-42	80-217-42	80-218-42
44 cm	80-206-44	80-207-44	80-208-44	80-209-44	80-210-44	80-211-44	80-212-44	80-213-44	80-214-44	80-215-44	80-216-44	80-217-44	80-218-44
46 cm	80-206-46	80-207-46	80-208-46	80-209-46	80-210-46	80-211-46	80-212-46	80-213-46	80-214-46	80-215-46	80-216-46	80-217-46	80-218-46
48 cm	80-206-48	80-207-48	80-208-48	80-209-48	80-210-48	80-211-48	80-212-48	80-213-48	80-214-48	80-215-48	80-216-48	80-217-48	80-218-48
50 cm	80-206-50	80-207-50	80-208-50	80-209-50	80-210-50	80-211-50	80-212-50	80-213-50	80-214-50	80-215-50	80-216-50	80-217-50	80-218-50
52 cm	80-206-52	80-207-52	80-208-52	80-209-52	80-210-52	80-211-52	80-212-52	80-213-52	80-214-52	80-215-52	80-216-52	80-217-52	80-218-52

# Knochennagelung

## Bone Nailing

### Enclavamiento de hueso

#### Küntscher Nagel für Unterschenkel und Oberarm

#### Küntscher Intramedullary Nail for Humerus and Tibia

#### Clavo de Küntscher intramedular para humero y tibia



Dia Length	6 mm	7 mm	8 mm	9 mm	10 mm	11 mm	12 mm	13 mm	14 mm	15 mm	16 mm	17 mm	18 mm
14 cm	80-306-14	80-307-14	80-308-14	80-309-14	80-310-14	80-311-14	80-312-14	80-313-14	80-314-14	80-315-14	80-316-14	80-317-14	80-318-14
16 cm	80-306-16	80-307-16	80-308-16	80-309-16	80-310-16	80-311-16	80-312-16	80-313-16	80-314-16	80-315-16	80-316-16	80-317-16	80-318-16
18 cm	80-306-18	80-307-18	80-308-18	80-309-18	80-310-18	80-311-18	80-312-18	80-313-18	80-314-18	80-315-18	80-316-18	80-317-18	80-318-18
20 cm	80-306-20	80-307-20	80-308-20	80-309-20	80-310-20	80-311-20	80-312-20	80-311-20	80-314-20	80-315-20	80-316-20	80-317-20	80-318-20
22 cm	80-306-22	80-307-22	80-308-22	80-309-22	80-310-22	80-311-22	80-312-22	80-313-22	80-314-22	80-315-22	80-316-22	80-317-22	80-318-22
24 cm	80-306-24	80-307-24	80-308-24	80-309-24	80-310-24	80-311-24	80-312-24	80-313-24	80-314-24	80-315-24	80-316-24	80-317-24	80-318-24
26 cm	80-306-26	80-307-26	80-308-26	80-309-26	80-310-26	80-311-26	80-312-26	80-313-26	80-314-26	80-315-26	80-316-26	80-317-26	80-318-26
28 cm	80-306-28	80-307-28	80-308-28	80-309-28	80-310-28	80-311-28	80-312-28	80-313-28	80-314-28	80-315-28	80-316-28	80-317-28	80-318-28
30 cm	80-306-30	80-307-30	80-308-30	80-309-30	80-310-30	80-311-30	80-312-30	80-313-30	80-314-30	80-315-30	80-316-30	80-317-30	80-318-30
32 cm	80-306-32	80-307-32	80-308-32	80-309-32	80-310-32	80-311-32	80-312-32	80-313-32	80-314-32	80-315-32	80-316-32	80-317-32	80-318-32
34 cm	80-306-34	80-307-34	80-308-34	80-309-34	80-310-34	80-311-34	80-312-34	80-313-34	80-314-34	80-315-34	80-316-34	80-317-34	80-318-34
36 cm	80-306-36	80-307-36	80-308-36	80-309-36	80-310-36	80-311-36	80-312-36	80-313-36	80-314-36	80-315-36	80-316-36	80-317-36	80-318-36
38 cm	80-306-38	80-307-38	80-308-38	80-309-38	80-310-38	80-311-38	80-312-38	80-313-38	80-314-38	80-315-38	80-316-38	80-317-38	80-318-38
40 cm	80-306-40	80-307-40	80-308-40	80-309-40	80-310-40	80-311-40	80-312-40	80-313-40	80-314-40	80-315-40	80-316-40	80-317-40	80-318-40
42 cm	80-306-42	80-307-42	80-308-42	80-309-42	80-310-42	80-311-42	80-312-42	80-313-42	80-314-42	80-315-42	80-316-42	80-317-42	80-318-42
44 cm	80-306-44	80-307-44	80-308-44	80-309-44	80-310-44	80-311-44	80-312-44	80-313-44	80-314-44	80-315-44	80-316-44	80-317-44	80-318-44
46 cm	80-306-46	80-307-46	80-308-46	80-309-46	80-310-46	80-311-46	80-312-46	80-313-46	80-314-46	80-315-46	80-316-46	80-317-46	80-318-46
48 cm	80-306-48	80-307-48	80-308-48	80-309-48	80-310-48	80-311-48	80-312-48	80-313-48	80-314-48	80-315-48	80-316-48	80-317-48	80-318-48
50 cm	80-306-50	80-307-50	80-308-50	80-309-50	80-310-50	80-311-50	80-312-50	80-313-50	80-314-50	80-315-50	80-316-50	80-317-50	80-318-50
52 cm	80-306-52	80-307-52	80-308-52	80-309-52	80-310-52	80-311-52	80-312-52	80-313-52	80-314-52	80-315-52	80-316-52	80-317-52	80-318-52

Küntscher Nagel für Unterschenkel und Oberarm  
Küntscher Intramedullary Nail for Humerus and Tibia  
Clavo de Küntscher intramedular para humero y tibia



Dia Length	6 mm	7 mm	8 mm	9 mm	10 mm	11 mm	12 mm	13 mm	14 mm	15 mm	16 mm	17 mm	18 mm
14 cm	80-406-14	80-407-14	80-408-14	80-409-14	80-410-14	80-411-14	80-412-14	80-413-14	80-414-14	80-415-14	80-416-14	80-417-14	80-418-14
16 cm	80-406-16	80-407-16	80-408-16	80-409-16	80-410-16	80-411-16	80-412-16	80-413-16	80-414-16	80-415-16	80-416-16	80-417-16	80-418-16
18 cm	80-406-18	80-407-18	80-408-18	80-409-18	80-410-18	80-411-18	80-412-18	80-413-18	80-414-18	80-415-18	80-416-18	80-417-18	80-418-18
20 cm	80-406-20	80-407-20	80-408-20	80-409-20	80-410-20	80-411-20	80-412-20	80-413-20	80-414-20	80-415-20	80-416-20	80-417-20	80-418-20
22 cm	80-406-22	80-407-22	80-408-22	80-409-22	80-410-22	80-411-22	80-412-22	80-413-22	80-414-22	80-415-22	80-416-22	80-417-22	80-418-22
24 cm	80-406-24	80-407-24	80-408-24	80-409-24	80-410-24	80-411-24	80-412-24	80-413-24	80-414-24	80-415-24	80-416-24	80-417-24	80-418-24
26 cm	80-406-26	80-407-26	80-408-26	80-409-26	80-410-26	80-411-26	80-412-26	80-413-26	80-414-26	80-415-26	80-416-26	80-417-26	80-418-26
28 cm	80-406-28	80-407-28	80-408-28	80-409-28	80-410-28	80-411-28	80-412-28	80-413-28	80-414-28	80-415-28	80-416-28	80-417-28	80-418-28
30 cm	80-406-30	80-407-30	80-408-30	80-409-30	80-410-30	80-411-30	80-412-30	80-413-30	80-414-30	80-415-30	80-416-30	80-417-30	80-418-30
32 cm	80-406-32	80-407-32	80-408-32	80-409-32	80-410-32	80-411-32	80-412-32	80-413-32	80-414-32	80-415-32	80-416-32	80-417-32	80-418-32
34 cm	80-406-34	80-407-34	80-408-34	80-409-34	80-410-34	80-411-34	80-412-34	80-413-34	80-414-34	80-415-34	80-416-34	80-417-34	80-418-34
36 cm	80-406-36	80-407-36	80-408-36	80-409-36	80-410-36	80-411-36	80-412-36	80-413-36	80-414-36	80-415-36	80-416-36	80-417-36	80-418-36
38 cm	80-406-38	80-407-38	80-408-38	80-409-38	80-410-38	80-411-38	80-412-38	80-413-38	80-414-38	80-415-38	80-416-38	80-417-38	80-418-38
40 cm	80-406-40	80-407-40	80-408-40	80-409-40	80-410-40	80-411-40	80-412-40	80-413-40	80-414-40	80-415-40	80-416-40	80-417-40	80-418-40
42 cm	80-406-42	80-407-42	80-408-42	80-409-42	80-410-42	80-411-42	80-412-42	80-413-42	80-414-42	80-415-42	80-416-42	80-417-42	80-418-42
44 cm	80-406-44	80-407-44	80-408-44	80-409-44	80-410-44	80-411-44	80-412-44	80-413-44	80-414-44	80-415-44	80-416-44	80-417-44	80-418-44
46 cm	80-406-46	80-407-46	80-408-46	80-409-46	80-410-46	80-411-46	80-412-46	80-413-46	80-414-46	80-415-46	80-416-46	80-417-46	80-418-46
48 cm	80-406-48	80-407-48	80-408-48	80-409-48	80-410-48	80-411-48	80-412-48	80-413-48	80-414-48	80-415-48	80-416-48	80-417-48	80-418-48
50 cm	80-406-50	80-407-50	80-408-50	80-409-50	80-410-50	80-411-50	80-412-50	80-413-50	80-414-50	80-415-50	80-416-50	80-417-50	80-418-50
52 cm	80-206-52	80-407-52	80-408-52	80-409-52	80-410-52	80-411-52	80-412-52	80-413-52	80-414-52	80-415-52	80-416-52	80-417-52	80-418-52

**Instrumente zur intramedullären Knochennagelung**  
**Instruments for Intramedullary Nailing**  
**Instrumentos para enclavamiento intramedular**



80-420-08    Pfriem für Tibia 8 mm  
Awl for Tibia 8 mm  
Punzon para tibia 8 mm

80-420-10    Pfriem für Femur 10 mm  
Awl for Femur 10 mm  
Punzon para femur 10 mm



80-430-00    Pfriem  
Reamer  
Punzon

**Instrumente zur intramedullären Knochen Nagelung**  
**Instruments for Intramedullary Nailing**  
**Instrumentos para enclavamiento intramedular**



80-440-00 Hammer geschlitzt  
Slotted Hammer  
Martillo diapason



80-450-00 Einschläger  
Slotted Nail Driver  
Percutor recto



80-460-10  
Nachschläger für Nägel ø 6 - 10 mm  
Nail Driver for Nails ø 6 - 10 mm  
Impactor final para clavos ø 6 - 10 mm

80-460-12  
Nachschläger für Nägel ø 9 - 12 mm  
Nail Driver for Nails ø 9 - 12 mm  
Impactor final para clavos ø 9 - 12 mm

80-460-20  
Nachschläger für Nägel ø 13 - 20 mm  
Nail Driver for Nails ø 13 - 20 mm  
Impactor final para clavos ø 13 - 20 mm

**Instrumente zur intramedullaren Knochennagelung**  
**Instruments for Intramedullary Nailing**  
**Instrumentos para enclavamiento intramedular**



Ausziehhaken  
 Extraction Hook  
 Extractor de clavos

- 80-470-29    ø 5 mm, Long. 29,0 cm
- 80-470-37    ø 5 mm, Long. 37,0 cm
- 80-470-43    ø 5 mm, Long. 43,0 cm
- 80-470-51    ø 5 mm, Long. 51,0 cm



80-480-00    Nagelextractor mit Schlaggewicht mit 2 Haken  
 Nail Extractor with Sliding Mallet with 2 hooks  
 Extractor con maza deslizante con 2 ganchos



Flexibler Markraumböhrer  
 Flexible Medullary Reamer  
 Perforadora medular flexible

ø	6,0 mm 80-506-00	6,5 mm 80-506-05	7,0 mm 80-507-00	7,5 mm 80-507-05	8,0 mm 80-508-00	8,5 mm 80-508-05	
ø	9,0 mm 80-509-00	9,5 mm 80-509-05	10,0 mm 80-510-00	10,5 mm 80-510-05	11,0 mm 80-511-00	11,5 mm 80-511-05	
ø	12,0 mm 80-512-00	12,5 mm 80-512-05	13,0 mm 80-513-00	13,5 mm 80-513-05	14,0 mm 80-514-00	14,5 mm 80-514-05	
ø	15,0 mm 80-515-00	15,5 mm 80-515-05	16,0 mm 80-516-00	16,5 mm 80-516-05	17,0 mm 80-517-00	17,5 mm 80-570-05	18,0 mm 80-518-00

**Instrumente zur intramedullären Knochen Nagelung**  
**Instruments for Intramedullary Nailing**  
**Instrumentos para enclavamiento intramedular**

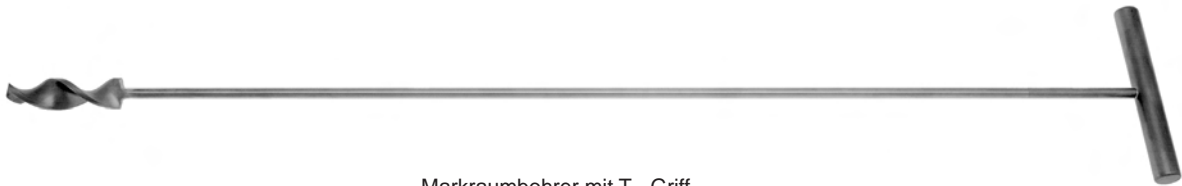

Markraumborner mit T - Griff  
 Reamer with T - Handle  
 Perforador medular con mango en T

∅	6,0 mm 80-520-06	7,0 mm 80-520-07	8,0 mm 80-520-08	9,0 mm 80-520-09	10,0 mm 80-520-10	11,0 mm 80-520-11
∅	12,0 mm 80-520-12	13,0 mm 80-520-13	14,0 mm 80-520-14	15,0 mm 80-520-15	16,0 mm 80-520-16	17,0 mm 80-520-17
∅	18,0 mm 80-520-18	19,0 mm 80-520-19	20,0 mm 80-520-20			



Führungsdraht  
 Guide Pin  
 Guia conductora

80-530-60	Dia. 3,0 mm, Long. 60,0 cm
80-535-60	Dia. 3,5 mm, Long. 60,0 cm
80-540-60	Dia. 4,0 mm, Long. 60,0 cm
80-550-60	Dia. 5,0 mm, Long. 60,0 cm

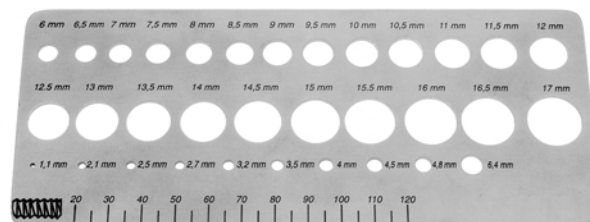

80-560-00 Lochlehre für Nägel  
 Measuring Gauge for Nails  
 Medidor para Clavos

# Knochennagelung

## Bone Nailing

### Enclavamiento de hueso

---

#### Rund - Nägel zur intramedullären Nagelung Round Pins for intramedullary Nailing Clavos redondos intramedulares con gancho



ø 2,4 mm	25 mm 80-600-24	30 mm 80-601-24	40 mm 80-602-24	50 mm 80-603-24	60 mm 80-604-24	65 mm 80-605-24	70 mm 80-606-24
	75 mm 80-607-24	85 mm 80-608-24	90 mm 80-609-24	100 mm 80-610-24	115 mm 80-611-24	125 mm 80-612-24	140 mm 80-613-24
	150 mm 80-614-24	165 mm 80-615-24	180 mm 80-616-24	190 mm 80-617-24	205 mm 80-618-24	215 mm 80-619-24	230 mm 80-620-24
	240 mm 80-621-24	255 mm 80-622-24					
ø 3,2 mm	100 mm 80-630-32	115 mm 80-631-32	125 mm 80-632-32	140 mm 80-633-32	150 mm 80-634-32	165 mm 80-635-32	180 mm 80-636-32
	190 mm 80-637-32	205 mm 80-638-32					
ø 4,8 mm	205 mm 80-640-48	220 mm 80-641-48	240 mm 80-642-48	255 mm 80-643-48	280 mm 80-644-48	295 mm 80-645-48	315 mm 80-646-48
	335 mm 80-647-48	355 mm 80-648-48					
ø 6,4 mm	280 mm 80-650-64	290 mm 80-651-64	315 mm 80-652-64	335 mm 80-653-64	355 mm 80-654-64	375 mm 80-655-64	395 mm 80-656-64
	410 mm 80-657-64						



**Rund - Nägel zur intramedullären Nagelung**  
**Round Pins for intramedullary Nailing**  
**Clavos redondos intramedulares con gancho**



Rush - Rundnägel - Set  
Rush Medullary Pin Set  
Set de Clavos redondos con gancho

Art. Nr. Cat. No. Cat. No.	Durchmesser Diameter Diametro	Stück Pieces Piezas
80-660-24	2,4 mm	13
80-665-24	2,4 mm	13
80-670-32	3,2 mm	13
80-670-48	4,8 mm	9
80-670-64	6,4 mm	9

**Instrumente zur intramedullaren Knochennagelung**  
**Instruments for Intramedullary Nailing**  
**Instrumentos para enclavamiento intramedular**

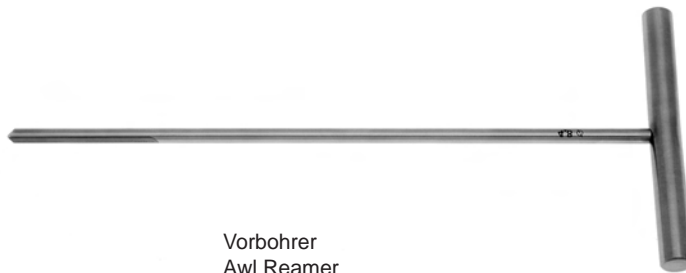

Vorbohrer  
Awl Reamer  
Preperforador

80-670-24	∅ 2,4 mm
80-670-32	∅ 3,2 mm
80-670-48	∅ 4,8 mm
80-670-64	∅ 6,4 mm



Extractor  
Driver and Extractor  
Extractor

80-680-24	∅ 2,4 mm
80-680-32	∅ 3,2 mm
80-680-48	∅ 4,8 mm
80-680-64	∅ 6,4 mm



80-690-00    Biegeisen  
Bender  
Llave dobladora



**Flexible Knochenschienen**  
**Flexible Medullary Nails**  
**Clavos medulares flexibles**



Art. Nr. Cat. No. Cat. No.	Länge Length Longitud	Durchmesser Diameter Diámetro
80-700-30	300 mm	4,5 mm
80-700-31	310 mm	4,5 mm
80-700-32	320 mm	4,5 mm
80-700-33	330 mm	4,5 mm
80-700-34	340 mm	4,5 mm
80-700-35	350 mm	4,5 mm
80-700-36	360 mm	4,5 mm
80-700-37	370 mm	4,5 mm
80-700-38	380 mm	4,5 mm
80-700-39	390 mm	4,5 mm
80-700-40	400 mm	4,5 mm
80-700-41	410 mm	4,5 mm
80-700-42	420 mm	4,5 mm
80-700-43	430 mm	4,5 mm
80-700-44	440 mm	4,5 mm
80-700-45	450 mm	4,5 mm
80-700-46	460 mm	4,5 mm
80-700-47	470 mm	4,5 mm
80-700-48	480 mm	4,5 mm
80-700-49	490 mm	4,5 mm

**Instrumente zur intramedullären Knochen Nagelung**  
**Instruments for Intramedullary Nailing**  
**Instrumentos para enclavamiento intramedular**



80-710-00 Nachschläger  
Nail Inserter  
Impactor final



80-720-00 Einschläger - Ausschläger  
Impactor - Extractor  
Impactor - Extracor de cierre automatico

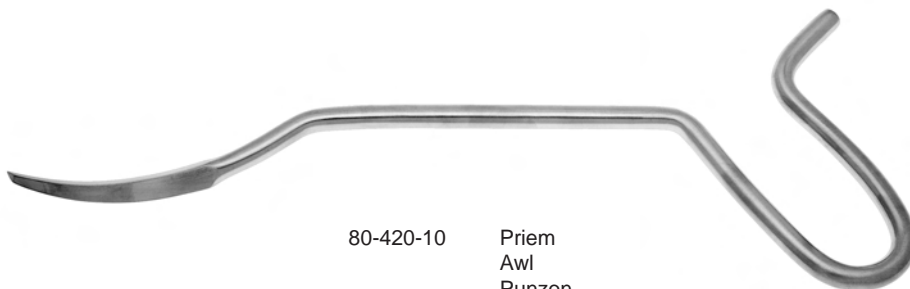

80-420-10 Priem  
Awl  
Punzon

**Knochennagelung**  
**Bone Nailing**  
**Enclavamiento de hueso**

---

**Instrumente zur intramedullaren Knochennagelung**  
**Instruments for Intramedullary Nailing**  
**Instrumentos para enclavamiento intramedular**



80-690-00    Biegeeisen  
Bender  
Llave dobladora

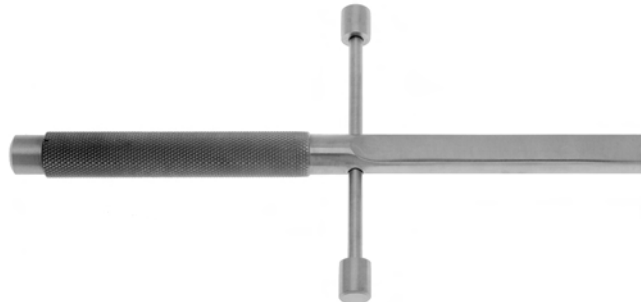

80-730-00    Einschläger  
Impactor  
Mango impactor conductor



80-740-00    Extractor mit Schlaggewicht  
Extractor with Sliding Mallet  
Extractor con maza deslizante



**Knochennagelung**  
**Bone Nailing**  
**Enclavamiento de hueso**

---





**Minifragmentsortiment**  
**Set of Minifragment**  
**Sortimento de minifragmentos**

# Minifragmentsortiment

## Set of Minifragment

### Sortimento de minifragmentos

#### Minifragment - Schrauben 1,5 mm / 2,0 mm

#### Minifragment - Screws 1,5 mm / 2,0 mm

#### Tornillos para Minifragmeto 1,5 / 2,0 mm

Corticalisschrauben 1,5 mm  
Cortical Screws 1,5 mm  
Tornillos corticales 1,5 mm

Art. Nr.	Länge
Cat. No.	Length
Cat. No.	Longitud

81-100-00	6 mm
81-100-02	7 mm
81-100-04	8 mm
81-100-06	9 mm
81-100-08	10 mm
81-100-10	11 mm
81-100-12	12 mm
81-100-14	14 mm
81-100-16	16 mm
81-100-18	18 mm
81-100-20	20 mm



**1,5 mm**

Gewindedurchmesser	1,5 mm
Kerndurchmesser	1,0 mm
Kopfdurchmesser	3,0 mm
Innensechskant	1,5 mm
Bohrer für Gewindeloch	1,1 mm
Bohrer für Gleitloch	1,5 mm

Diameter of thread	1,5 mm
Diameter of core	1,0 mm
Diameter of head	3,0 mm
Imbus	1,5 mm
Drill bit for thread hole	1,1 mm
Drill bit for sliding hole	1,5 mm

Diametro de la rosca	1,5 mm
Diametro del nucleo	1,0 mm
Diametro de la cabeza	3,0 mm
Hexagono interior	1,5 mm
Broca para orificio de roscar	1,1 mm
Broca para orificio deslizante	1,5 mm

Corticalisschrauben 2,0 mm  
Cortical Screws 2,0 mm  
Tornillos corticales 2,0 mm

Art. Nr.	Länge
Cat. No.	Length
Cat. No.	Longitud

81-110-00	6 mm
81-110-02	8 mm
81-110-04	10 mm
81-110-06	12 mm
81-110-08	14 mm
81-110-10	16 mm
81-110-12	18 mm
81-110-14	20 mm
81-110-16	22 mm
81-110-18	24 mm
81-110-20	26 mm
81-110-22	28 mm
81-110-24	30 mm
81-110-26	32 mm
81-110-28	34 mm
81-110-30	36 mm
81-110-32	38 mm



**2,0 mm**

Gewindedurchmesser	2,0 mm
Kerndurchmesser	1,3 mm
Kopfdurchmesser	4,0 mm
Innensechskant	1,5 mm
Bohrer für Gewindeloch	1,5 mm
Bohrer für Gleitloch	2,0 mm

Diameter of thread	2,0 mm
Diameter of core	1,3 mm
Diameter of head	4,0 mm
Imbus	1,5 mm
Drill bit for thread hole	1,5 mm
Drill bit for sliding hole	2,0 mm

Diametro de la rosca	2,0 mm
Diametro del nucleo	1,3 mm
Diametro de la cabeza	4,0 mm
Hexagono interior	1,5 mm
Broca para orificio de roscar	1,5 mm
Broca para orificio deslizante	2,0 mm

**Minifragment - Schrauben 2,7 mm**  
**Minifragment - Screws 2,7 mm**  
**Tornillos para Minifragmento 2,7 mm**

Corticalisschrauben 2,7 mm  
 Cortical Screws 2,7 mm  
 Tornillos corticales 2,7 mm

Art. Nr.	Länge
Cat. No.	Length
Cat. No.	Longitud

81-120-00	6 mm
81-120-02	8 mm
81-120-04	10 mm
81-120-06	12 mm
81-120-08	14 mm
81-120-10	16 mm
81-120-12	18 mm
81-120-14	20 mm
81-120-16	22 mm
81-120-18	24 mm
81-120-20	26 mm
81-120-22	28 mm
81-120-24	30 mm
81-120-26	32 mm
81-120-28	34 mm
81-120-30	36 mm
81-120-32	38 mm
81-120-34	40 mm



**2,7 mm**

Gewindedurchmesser	2,7 mm
Kerndurchmesser	1,9 mm
Kopfdurchmesser	5,0 mm
Innensechskant	2,5 mm
Bohrer für Gewindeloch	2,0 mm
Bohrer für Gleichtloch	2,7 mm

Diameter of thread	2,7 mm
Diameter of core	1,9 mm
Diameter of head	5,0 mm
Imbus	2,5 mm
Drill bit for thread hole	2,0 mm
Drill bit for hole	2,7 mm

Diametro de la rosca	2,7 mm
Diametro del nucleo	1,9 mm
Diametro de la cabeza	5,0 mm
Hexagono interior	2,5 mm
Broca para orificio de roscar	2,0 mm
Broca para orificio deslizante	2,7 mm

# Minifragmentsortiment

## Set of Minifragment

### Sortimento de minifragmento

---

#### Minifragment - Platten für 1,5 mm Schrauben

#### Minifragment - Plates for 1,5 mm Screws

#### Placas para Minifragmento para tornillos 1,5 mm

Gerade Miniplatte, 1,5 mm  
 Straight Mini Plate, 1,5 mm  
 Mini placa recta, 1,5 mm

Art. Nr.	Lochzahl	Länge
Cat. No.	Holes	Length
Cat. No.	Agujeros	Longitud
81-130-00	20	100 mm



**Profil:**  
**Dicke:** 0,9 mm  
**Breite:** 3,8 mm  
**Lochabstand:** 5,0 mm

Mini T Platte, 1,5 mm 9 Loch  
 Mini T Plate, 1,5 mm 9 Holes  
 Mini placa en forma de T, 1,5 mm 9 agujeros

Art. Nr.	Bezeichnung	Lochzahl im Kopf
Cat. No.	Description	Holes in head
Cat. No.	Descrpicion	Agujeros en cabeza
81-140-10	T - Platte	3
81-140-20	T - Platte	4



**Profil:**  
**Dicke:** 0,9 mm  
**Breite:** 3,8 mm  
**Lochabstand:** 5,0 mm

**Minifragment - Platten für 1,5 mm und 2,0 mm Schrauben**  
**Minifragment - Plates for 1,5 mm and 2,0 mm Screws**  
**Placas para Minifragmento para tornillos de 1,5 mm y 2,0 mm**

Gerade Miniplatte, 2,0 mm  
Straight Mini Plate, 2,0 mm  
Mini placa recta, 2,0 mm

Art. Nr. Cat. No. Cat. No.	Lochzahl Holes Agujeros	Länge Length Longitud
81-150-05	3	17 mm
81-150-10	4	23 mm
81-150-15	5	29 mm
81-150-20	6	35 mm



**Profil:**  
**Dicke:** 0,9 mm  
**Breite:** 5,0 mm  
**Lochabstand:** 6,0 mm

Kompressionsplatte, 2,0 mm  
Dynamic Plate, 2,0 mm  
Placa de autocompresion, 2,0 mm

Art. Nr. Cat. No. Cat. No.	Lochzahl Holes Agujeros	Länge Length Longitud
81-160-00	3	17 mm
81-160-05	4	22 mm
81-160-10	5	27 mm
81-160-15	6	32 mm
81-160-20	7	37 mm
81-160-25	8	42 mm



**Profil:**  
**Dicke ( 4 - 6 Loch):** 1,0 mm  
**Dicke ( 7 - 8 Loch):** 1,5 mm  
**Breite:** 5,0 mm  
**Lochabstand:** 5,0 mm

Gerade Miniplatte, 2,0 mm  
Straght Mini Plate, 2,0 mm  
Mini placa recta, 2,0 mm

Art. Nr. Cat. No. Cat. No.	Lochzahl Holes Agujeros	Länge Length Longitud
81-170-00	20	100 mm



**Profil:**  
**Dicke:** 1,2 mm  
**Breite:** 5,0 mm  
**Lochabstand:** 5,0 mm

# Minifragmentsortiment

## Set of Minifragment

### Sortimento de minifragmento

#### Minifragment - Platten für 1,5 mm und 2,0 mm Schrauben

#### Minifragment - Plates for 1,5 mm and 2,0 mm Screws

#### Placas de Minifragmento para tornillos de 1,5 mm y 2,0 mm

Mini L - und T Platten, 2,0 mm  
 Mini L - and T Plates, 2,0 mm  
 Mini Placas en forma de L y T, 2,0 mm

Art. Nr. Cat. No. Cat. No.	Bezeichnung Description Descripción
81-180-00	L - Platte links
81-180-05	L - Platte rechts
81-180-10	L - Platte schräg links
81-180-15	L - Platte schräg rechts
81-180-20	T - Platte



**Profil:**  
**Dicke:** 1,0 mm  
**Breite:** 5,0 mm  
**Lochabstand:** 6,0 mm  
 leicht hohl

Mini T Platten, 2,0 mm Schaft 9 Loch  
 Mini T Plates, 2,0 mm Shaft 9 Holes  
 Mini Placas en forma de T, 2,0 mm

Art. Nr. Cat. No. Cat. No.	Bezeichnung Description Descripción	Lochzahl im Kopf Holes in head Agujeros en cabeza
81-190-00	T - Platte	3
81-190-05	T - Platte	4

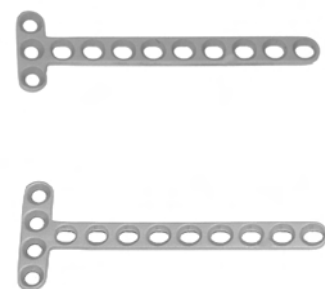

**Profil:**  
**Dicke:** 1,2 mm  
**Breite:** 5,0 mm  
**Lochabstand:** 5,0 mm

**Minifragment - Platten für 1,5 mm und 2,0 mm Schrauben**  
**Minifragment - Plates for 1,5 mm and 2,0 mm Screws**  
**Placas de Minifragmento para tornillos de 1,5 mm y 2,0 mm**

Mini Adaptationsplatte, 2,0 mm  
Mini Adaptation Plate, 2,0 mm  
Mini Placas para adaptacion, 2,0 mm

Art. Nr.	Lochzahl	Länge
Cat. No.	Holes	Length
Cat. No.	Agujeros	Longitud

81-200-00	20	100 mm
-----------	----	--------



<b>Profil:</b>	
<b>Dicke:</b>	<b>0,9 mm</b>
<b>Breite:</b>	<b>5,0 mm</b>
<b>Lochabstand:</b>	<b>5,0 mm</b>

# Minifragmentsortiment

## Set of Minifragment

### Sortimento de minifragmento

---

#### Minifragment - Platten für 2,7 mm Schrauben

#### Minifragment - Plates for 2,7 mm Screws

#### Placas para Minifragmento para tornillos 2,7 mm

Viertelrohrplatte, 2,7 mm  
Quarter tube Plates, 2,7 mm  
Placa cuarto de tubo, 2,7 mm

Art. Nr.	Lochzahl	Länge
Cat. No.	Holes	Length
Cat. No.	Agujeros	Longitud
81-210-00	3	23 mm
81-210-05	4	31 mm
81-210-10	5	39 mm
81-210-15	6	47 mm
81-210-20	7	55 mm
81-210-25	8	63 mm
81-210-30	9	76 mm
81-210-35	10	84 mm
81-210-40	12	100 mm



**Profil:**  
**Dicke:** 1,0 mm  
**Breite:** 7,0 mm  
**Lochabstand:** 8,0 mm

Kompressionsplatte 2,7 mm  
Dynamic Plate 2,7 mm  
Placa de autocompresion 2,7 mm

Art. Nr.	Lochzahl	Länge
Cat. No.	Holes	Length
Cat. No.	Agujeros	Longitud
81-220-00	2	20 mm
81-220-05	3	28 mm
81-220-10	4	36 mm
81-220-15	5	44 mm
81-220-20	6	52 mm
81-220-25	7	60 mm
81-220-30	8	68 mm
81-220-35	9	76 mm
81-220-40	10	84 mm
81-220-45	11	92 mm
81-220-50	12	100 mm



**Profil:**  
**Dicke ( 2 - 6 Loch):** 2,0 mm  
**Dicke ( 7 - 12 Loch):** 2,5 mm  
**Breite:** 8,0 mm  
**Lochabstand:** 8,0 mm  
12,0 mm



**Minifragment - Platten für 2,7 mm Schrauben**  
**Minifragment - Plates for 2,7 mm Screws**  
**Placas para Minifragmento para tornillos 2,7 mm**

Mehrfragmentplatte 2,7 mm  
Multiple Fragment Plate 2,7 mm  
Placa para multifragmentos 2,7 mm

Art. Nr. Lochzahl  
Cat. No. Holes  
Cat. No. Agujeros

81-230-00 7



Kleine L - und T Platten, 2,7 mm  
Small L - and T Plates, 2,7 mm  
Placas pequeñas en forma de L y T, 2,7 mm

Art. Nr.	Bezeichnung
Cat. No.	Description
Cat. No.	Descrpcion
81-240-00	L - Platte links
81-240-05	L - Platte rechts
81-240-10	L - Platte schräg links
81-240-15	L - Platte schräg rechts
81-240-20	T - Platte



**Profil:**  
**Dicke:** 1,2 mm  
**Breite:** 7,0 mm  
**Lochabstand:** 8,0 mm



Rekonstruktionsplatte 2,7 mm  
Reconstruction plate 2,7 mm  
Placa de reconstruction 2,7 mm

Art. Nr.	Lochzahl	Länge	Art. Nr.	Lochzahl	Länge
Cat. No.	Holes	Length	Cat. No.	Holes	Length
Cat. No.	Agujeros	Longitud	Cat. No.	Agujeros	Longitud
81-250-00	5	58 mm	81-250-35	12	142 mm
81-250-05	6	70 mm	81-250-40	13	154 mm
81-250-10	7	82 mm	81-250-45	14	166 mm
81-250-15	8	94 mm	81-250-50	15	178 mm
81-250-20	9	106 mm	81-250-55	16	190 mm
81-250-25	10	118 mm	81-250-60	18	214 mm
81-250-30	11	130 mm			

# Minifragmentsortiment

## Set of Minifragment







### Sortimento de minifragmento

---

#### Instrumente für Schrauben $\varnothing$ 1,5 mm und $\varnothing$ 2,0 mm

#### Instruments for Screws $\varnothing$ 1,5 mm and $\varnothing$ 2,0 mm

#### Instrumentos para tornillos $\varnothing$ 1,5 mm y $\varnothing$ 2,0 mm

81-260-00	Spiralbohrer für Schnellkupplung $\varnothing$ 1,1 mm Drill Bit with end to fit quick coupling $\varnothing$ 1,1 mm Broca de acoplamiento rapido $\varnothing$ 1,1 mm	
81-270-00	Spiralbohrer für Schnellkupplung $\varnothing$ 1,5 mm Drill Bit with end to fit quick coupling $\varnothing$ 1,5 mm Broca de acoplamiento rapido $\varnothing$ 1,5 mm	
81-280-00	Mini - Kopfraumfräser Einsatz Mini Countersink Mini Avellanador	
81-290-00	Gewindeschneider $\varnothing$ 1,5 mm Tap $\varnothing$ 1,5 mm Macho $\varnothing$ 1,5 mm	
81-300-00	Gewindeschneider $\varnothing$ 2,0 mm Tap $\varnothing$ 2,0 mm Macho $\varnothing$ 2,0 mm	
81-310-00	Mini - Schraubenzieher - Einsatz 1,5 mm SW Mini hexagonal Screw Driver 1,5 mm Mini destornillador 1,5 mm	
81-320-00	Handstück mit Dentalverschluß Tap Handle with Dental coupling Mango de acoplamiento dental	

**Instrumente für Schrauben  $\varnothing$  1,5 mm und  $\varnothing$  2,0 mm**  
**Instruments for Screws  $\varnothing$  1,5 mm and  $\varnothing$  2,0 mm**  
**Instrumentos para tornillos  $\varnothing$  1,5 mm y  $\varnothing$  2,0 mm**



81-340-00 Mini - Bohrbuchse für Bohrer  $\varnothing$  1,1 mm und  $\varnothing$  1,5 mm  
Mini Drill Sleeve for Drill bit  $\varnothing$  1,1 mm and  $\varnothing$  1,5 mm  
Mini Guia de broca  $\varnothing$  1,1 mm y  $\varnothing$  1,5 mm



81-350-00 Neutral - und Spannbohrbuchse  $\varnothing$  2,0 mm  
Neutral and Load Drill Guide  $\varnothing$  2,0 mm  
Guia de broca neutral y para tension  $\varnothing$  2,0 mm



81-360-00 Sechskantschraubenzieher mit Griff und Haltehülse für 1,5 und 2,0 mm Schrauben  
Hexagonal Screwdriver with Holding Sleeve for 1,5 and 2,0 mm Screws  
Destornillador exagonal con dispositivo de agarre para tornillos de 1,5 mm y 2,0 mm



81-365-00 Haltehülse einzeln 1,5 mm  
Holding Sleeve 1,5 mm  
Pinza de sujecion 1,5 mm



81-370-00 Mini - Schraubenmeßgerät für 1,5 / 2,0 mm Schrauben  
Mini Depth Gauge for 1,5 / 2,0 mm Screws  
Mini medidor de profundidad para tornillos de 1,5 / 2,0 mm

# Minifragmentsortiment

## Set of Minifragment

### Sortimento de minifragmento

---

#### Instrumente für Schrauben ø 2,7 mm

#### Instruments for Screws ø 2,7 mm

#### Instrumentos para tornillos ø 2,7 mm

81-400-00 Spiralbohrer für Schnellkupplung ø 2,0 mm  
Drill Bit with end to fit quick couplig ø 2,0 mm  
Broca de acoplamiento rapido ø 2,0 mm



81-400-05 Spiralbohrer mit Rundschaft ø 2,0 mm  
Drill Bit with round end ø 2,0 mm  
Broca con vastago redondo rapido ø 2,0 mm



81-410-00 Spiralbohrer für Schnellkupplung ø 2,7 mm  
Drill Bit with end to fit quick couplig ø 2,7 mm  
Broca de acoplamiento rapido ø 2,7 mm



81-410-05 Spiralbohrer mit Rundschaft ø 2,7 mm  
Drill Bit with round end ø 2,7 mm  
Broca con vastago redondo ø 2,7 mm



81-420-00 Kleiner Kopfraumfräser - Einsatz, 2,7 mm  
Small Countersink, 2,7 mm  
Avellanador pequeño, 2,7 mm



81-430-00 Gewindeschneider ø 2,7 mm  
Tap ø 2,7 mm  
Macho ø 2,7 mm



81-440-00 Handstück mit Schnellkuppung  
Tap Handle with quick copling  
Mango de acoplamiento rapido



**Instrumente für Schrauben  $\varnothing$  2,7 mm**  
**Instruments for Screws  $\varnothing$  2,7 mm**  
**Instrumentos para tornillos  $\varnothing$  2,7 mm**



81-450-00 Ziel - und Platten - Bohrbuchse  
Drill Guide and Drill Sleeve  
Guia de broca con 3 orificios



81-460-00 Doppelbohrbüchse 2,7 / 2,0  
Double Drill Sleeve 2,7 mm / 2,0 mm  
Guia de broca doble 2,7 mm / 2,0 mm



81-470-00 Neutral - und Spannbohrbüchse  $\varnothing$  2,7 mm  
Neutral and Load Drill Guide  $\varnothing$  2,7 mm  
Guia de broca neutral y para tension  $\varnothing$  2,7 mm



81-480-00 Geweschutzhülse  $\varnothing$  3,5 mm für Gewindeschneider  $\varnothing$  2,7 mm  
Tap Sleeve 3,5 mm for taps  $\varnothing$  2,7 mm  
Guia de broca 3,5 mm para machos  $\varnothing$  2,7 mm

# Minifragmentsortiment

## Set of Minifragment

### Sortimento de minifragmento

---

#### Instrumente für Schrauben $\varnothing$ 2,7 mm

#### Instruments for Screws $\varnothing$ 2,7 mm

#### Instrumentos para tornillos $\varnothing$ 2,7 mm

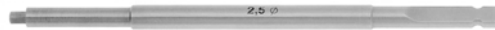

81-490-00 Kleiner Schraubenzieher - Einsatz SW 2,5 mm  
Small screw driver 2,5 mm  
Destornillador pequeño 2,5 mm



81-495-00 Haltehülse einzeln 2,5 mm  
Holding Sleeve 2,5 mm  
Pinza de sujecion 2,5 mm



81-500-00 Kleiner Schraubenzieher 6 - Kant, 2,5 mm SW  
Small Hexagonal screw Driver 2,5 mm  
Destornillador pequeño 2,5 mm



81-510-00 Schraubenmessgerät für kleine Schrauben  
Depth Guage for samll screws  
Medidor de profundidad para tornillos pequeños

**Mini - Instrumentarium**  
**Mini - Instrumentation**  
**Min - Instrumentario**



81-520-00 Schränkeisen für Fingerplättchen, 1,5 und 2,0  
Bending Iron for small Plates, 1,5 and 2,0  
Llave dobladora para placas pequeñas, 1,5 y 2,0



81-530-00 Biegezange für kleine Plättchen  
Bending Pliers for small Plates  
Teneza dobladora para placas pequeñas



81-380-00 Scharfer Haken  
Sharp Hook  
Gancho agudo



81-540-00 Haltezange für kleine Plättchen  
Holding Forceps for small Plates  
Teneza para agarrar placas pequeñas



81-550-00 Kleiner Knochenheber 6 mm  
Small Retractor 6 mm  
Retractor pequeño 6 mm

81-550-10 Kleiner Knochenheber 8 mm  
Small Retractor 8 mm  
Retractor pequeño 8 mm

**Minifragmentsortiment**  
**Set of Minifragment**  
**Sortimento de minifragmento**

---

**Mini - Instrumentarium**  
**Mini - Instrumentation**  
**Min - Instrumentario**



81-560-00 Kleiner Knochenheber für Kleinfragmente, 15 mm breit Länge 120 mm  
Small Retractor for small fragments, 15 mm broad, Length 120 mm  
Retractor pequeño para fragmentos pequeños, 15 mm ancho, Longitud 120 mm

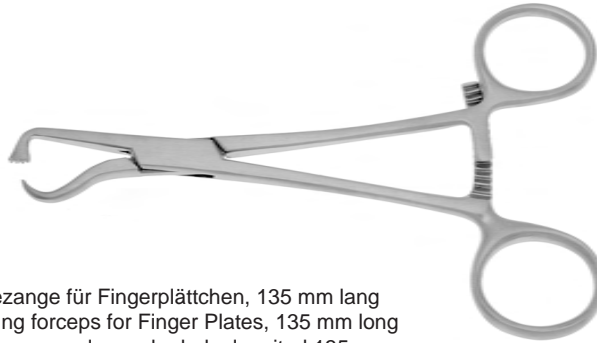

81-570-00 Haltezange für Fingerplättchen, 135 mm lang  
Holding forceps for Finger Plates, 135 mm long  
Tenaza para placas de dedo, longitud 135 mm

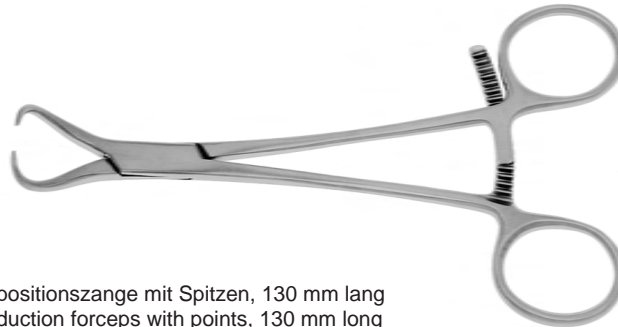

81-580-00 Repositionszange mit Spitzen, 130 mm lang  
Reduction forceps with points, 130 mm long  
Pinza de reduccion con puntas, longitud 130 mm



81-590-00 Raspatorium klein mit gerader Schneide 3 mm  
Periosteal Elevator small 3 mm  
Elevador periosteal pequeño 3 mm

81-590-05 Raspatorium klein mit gerader Schneide 6 mm  
Periosteal Elevator small 6 mm  
Elevador periosteal pequeño 6 mm



Minifragmentsortiment  
Set of Minifragment  
Sortimento de minifragmento

---



81-650-00    Repositionszange für Kleinfragmente  
Reduction forceps for Small fragment  
Pinza de reduccion para fragmentos pequeños



81-660-00    Selbstzentrierende Knochenhalte­zangen, Gewin­desperre Länge 150 mm  
Selfcentering Bone Holding Forceps  
Pinza de reduccion con bloque axial autocentrante



81-670-00    Schränkeisen  
Bending Iron for Small Plates  
Llave dobladora para placas pequeñas



81-670-10    Schränkeisen  
Bending Iron for Small Plates  
Llave dobladora para placas pequeñas

**Minifragmentsortiment**  
**Set of Minifragment**  
**Sortimento de minifragmento**

---



81-680-00    Kleine Biegezange für Draht und Platten  
Small Bending Forceps for Wire and Plates  
Pinza dobladora para alambre y placas



81-690-00    Kleiner Seitenschneider für Draht und Platten  
Lateral Wire Cutter for Wire and Plates  
Alicate de corte lateral



81-700-00    Biegebolzen für Spickdrähte  
Bending Iron for Wire  
Barra dobladora

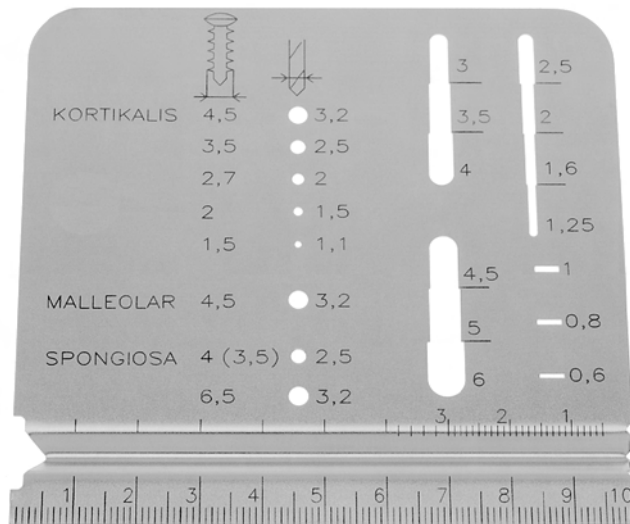

81-710-00 Messlehre für Schrauben  
Measuring Plate for screws  
Medidor para tornillos



81-720-00 Selbsthaltende Schraubenpinzette  
Screw Forceps selfholding  
Pinza fijadora

**Minifragmentsortiment**  
**Set of Minifragment**  
**Sortimento de minifragmento**

---



**Kleinfragmentsortiment**  
**Set of Smallfragment**  
**Sortimento de fragmentos pequeños**

# Kleinfragmentsortiment

## Set of Smallfragment

### Sortimento de fragmento pequeño

#### Kleinfragment - Schrauben

#### Small fragment Screws

#### Tornillos para fragmentos pequeños

Corticalisschrauben 3,5 mm Feingewinde 1,25  
 Cortical Screws 3,5 mm fine thread 1,25  
 Tornillos corticales 3,5 mm con rosca fina 1,25

Art. Nr.            Länge  
 Cat. No.           Length  
 Cat. No.           Longitud

82-100-00	8 mm
82-100-02	10 mm
82-100-04	12 mm
82-100-06	14 mm
82-100-08	16 mm
82-100-10	18 mm
82-100-12	20 mm
82-100-14	22 mm
82-100-16	24 mm
82-100-18	26 mm
82-100-20	28 mm
82-100-22	30 mm
82-100-24	32 mm
82-100-26	34 mm
82-100-28	36 mm
82-100-30	38 mm
82-100-32	40 mm
82-100-34	45 mm
82-100-36	50 mm
82-100-38	55 mm
82-100-40	60 mm
82-100-42	65 mm
82-100-44	70 mm
82-100-46	75 mm
82-100-48	80 mm
82-100-50	85 mm
82-100-52	90 mm
82-100-54	95 mm
82-100-56	100 mm
82-100-58	105 mm
82-100-60	110 mm



**3,5 / 1,25**

Gewindedurchmesser    3,5 mm  
 Kerndurchmesser        2,4 mm  
 Kopfdurchmesser        6,0 mm  
 Innensechskant         2,5 mm  
 Bohrer für Gewindeloch    2,5 mm  
 Bohrer für Gleichtloch    3,5 mm

Diameter of thread        3,5 mm  
 Diameter of core         2,4 mm  
 Diameter of head         6,0 mm  
 Imbus                      2,5 mm  
 Drill bit for thread hole    2,5 mm  
 Drill bit for sliding hole    3,5 mm

Diametro de la rosca      3,5 mm  
 Diametro del nucleo      2,4 mm  
 Diametro de la cabeza    6,0 mm  
 Hexagono interior        2,5 mm  
 Broca para orificio de roscar    2,5 mm  
 Broca para orificio deslizante    3,5 mm

# Kleinfragmentsortiment Set of Smallfragment Sortimento de fragmento pequeño

## Kleinfragment - Schrauben Small fragment Screws Tornillos para fragmentos pequeños

Corticalisschrauben 3,5 mm Grobgewinde 1,75  
Cortical Screws 3,5 mm with rough thread 1,75 mm  
Tornillos corticales 3,5 mm con rosca gruesa 1,75 mm

Art. Nr.  
Cat. No.  
Cat. No.

Länge  
Length  
Longitud

82-110-00	8 mm
82-110-02	10 mm
82-110-04	12 mm
82-110-06	14 mm
82-110-08	16 mm
82-110-10	18 mm
82-110-12	20 mm
82-110-14	22 mm
82-110-16	24 mm
82-110-18	26 mm
82-110-20	28 mm
82-110-22	30 mm
82-110-24	32 mm
82-110-26	34 mm
82-110-28	36 mm
82-110-30	38 mm
82-110-32	40 mm
82-110-34	45 mm
82-110-36	50 mm
82-110-38	55 mm
82-110-40	60 mm
82-110-42	65 mm
82-110-44	70 mm
82-110-46	75 mm
82-110-48	80 mm
82-110-50	85 mm
82-110-52	90 mm
82-110-54	95 mm
82-110-56	100 mm
82-110-58	105 mm
82-110-60	110 mm



**3,5 / 1,75**

Gewindedurchmesser 3,5 mm  
Kerndurchmesser 1,9 mm  
Kopfdurchmesser 6,0 mm  
Innensechskant 2,5 mm  
Bohrer für Gewindeloch 2,5 mm

Diameter of thread 3,5 mm  
Diameter of core 1,9 mm  
Diameter of head 6,0 mm  
Imbus 2,5 mm  
Drill bit for thread hole 2,5 mm

Diametro de la rosca 3,5 mm  
Diametro del nucleo 1,9 mm  
Diametro de la cabeza 6,0 mm  
Hexagono interior 2,5 mm  
Broca para orificio de roscar 2,5 mm

# Kleinfragmentsortiment

## Set of Smallfragment

### Sortimento de fragmento pequeño

---

#### Kleinfragment - Schrauben

#### Small fragment Screws

#### Tornillos de fragmentos pequeños

Spongiosasschrauben 4,0 mm mit durchgehendem Gewinde  
 Spongiosa Screws 4,0 mm full threaded  
 Tornillos esponjosa 4,0 mm con rosca continua

Art. Nr.	Länge
Cat. No.	Length
Cat. No.	Longitud
82-120-00	10 mm
82-120-02	12 mm
82-120-04	14 mm
82-120-06	16 mm
82-120-08	18 mm
82-120-10	20 mm
82-120-12	22 mm
82-120-14	24 mm
82-120-16	26 mm
82-120-18	28 mm
82-120-20	30 mm
82-120-22	32 mm
82-120-24	35 mm
82-120-26	40 mm
82-120-28	45 mm
82-120-30	50 mm
82-120-32	55 mm
82-120-34	60 mm



**Ø 4,0 mm**

Gewindedurchmesser	4,0 mm
Kerndurchmesser	1,9 mm
Kopfdurchmesser	6,0 mm
Innensechskant	2,5 mm
Bohrer für Gewindeloch	2,5 mm

Diameter of thread	4,0 mm
Diameter of core	1,9 mm
Diameter of head	6,0 mm
Imbus	2,5 mm
Drill bit for thread hole	2,5 mm

Diametro de la rosca	4,0 mm
Diametro del nucleo	1,9 mm
Diametro de la cabeza	6,0 mm
Hexagono interior	2,5 mm
Broca para orificio de roscar	2,5 mm



# Kleinfragmentsortiment Set of Smallfragment Sortimento de fragmento pequeño

## Kleinfragment - Schrauben Small fragment Screws Tornillos de fragmentos pequeños

Spongiosasschrauben 4,0 mm mit kurzem Gewinde  
Spongiosa Screws 4,0 mm with short thread  
Tornillos esponjosa 4,0 mm con rosca corta

Art. Nr. Cat. No. Cat. No.	Länge Length Longitud
82-130-00	10 mm
82-130-02	12 mm
82-130-04	14 mm
82-130-06	16 mm
82-130-08	18 mm
82-130-10	20 mm
82-130-12	22 mm
82-130-14	24 mm
82-130-16	26 mm
82-130-18	28 mm
82-130-20	30 mm
82-130-22	32 mm
82-130-24	35 mm
82-130-26	40 mm
82-130-28	45 mm
82-130-30	50 mm
82-130-32	55 mm
82-130-34	60 mm



Ø 4,0 mm

Gewindedurchmesser	4,0 mm
Kerndurchmesser	1,9 mm
Schaftdurchmesser	2,3 mm
Kopfdurchmesser	6,0 mm
Innensechskant	2,5 mm
Bohrer für Gewindeloch	2,5 mm

Diameter of thread	4,0 mm
Diameter of core	1,9 mm
Diameter of shaft	2,3 mm
Diameter of head	6,0 mm
Imbus	2,5 mm
Drill bit for thread hole	2,5 mm

Diametro de la rosca	4,0 mm
Diametro del nucleo	1,9 mm
Diametro de caña	2,3 mm
Diametro de la cabeza	6,0 mm
Hexagono interior	2,5 mm
Broca para orificio de roscar	2,5 mm

# Kleinfragmentsortiment

## Set of Smallfragment

### Sortimento de fragmento pequeño

---

#### Kleinfragment Gerade Platten

#### Small fragment straight plates

#### Placas rectas para pequeños fragmentos

Unterlagsscheibe  
Washer  
Arandela



82-140-00 7,0 mm

Drittellrohrplatte  
One - Third tube Plates  
Placa tercio de tubo

Art. Nr. Cat. No. Cat. No.	Lochzahl Holes Agujeros	Länge Length Longitud
82-150-00	2	25 mm
82-150-05	3	37 mm
82-150-10	4	49 mm
82-150-15	5	61 mm
82-150-20	6	73 mm
82-150-25	7	85 mm
82-150-30	8	97 mm
82-150-35	9	109 mm
82-150-40	10	121 mm
82-150-45	12	145 mm



DC - Platten 3,5 mm  
Small fragment plate for 3,5 mm screws  
Placa recta autocompression 3,5 mm

Art. Nr. Cat. No. Cat. No.	Lochzahl Holes Agujeros	Länge Length Longitud
82-160-00	2	25 mm
82-160-05	3	37 mm
82-160-10	4	49 mm
82-160-15	5	61 mm
82-160-20	6	73 mm
82-160-25	7	85 mm
82-160-30	8	97 mm
82-160-35	9	109 mm
82-160-40	10	121 mm
82-160-45	12	145 mm



**Kleinfragment Form Platten**  
**Small fragment formed plates**  
**Placas rectas para pequeños fragmentos de formas especiales**

Kleine T - Platte rechtwinklig  
Small fragment T - Plate right angle  
Placa pequeña en T angulo recto

Art. Nr.	Lochzahl	Länge
Cat. No.	Holes	Length
Cat. No.	Agujeros	Longitud
82-170-00	3	39 mm
82-170-10	5	67 mm



Kleine T - Platte rechtwinklig  
Small fragment T - Plate right angle  
Placa pequeña en T angulo recto

Art. Nr.	Lochzahl	Länge
Cat. No.	Holes	Length
Cat. No.	Agujeros	Longitud
82-180-00	4	56 mm
82-180-10	6	78 mm

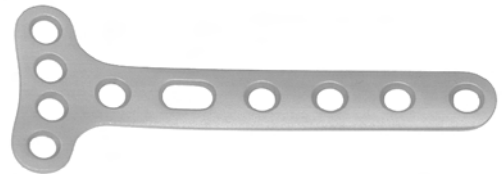

Kleine T - Platte schrägwinklig  
Small fragment T - Plate oblique angle  
Placa pequeña en T angulo oblicuo

Art. Nr.	Lochzahl	Länge
Cat. No.	Holes	Length
Cat. No.	Agujeros	Longitud
82-190-00	3	39 mm
82-190-10	5	67 mm

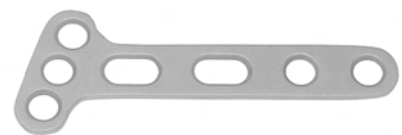

**Kleinfragmentsortiment**  
**Set of Smallfragment**  
**Sortimento de fragmento pequeño**

---

**Kleinfragment Form Platten**  
**Small fragment straight plates**  
**Placas rectas para pequeños fragmentos**

Kleeblattplatten 3,5 mm  
Cloverleaf plate 3,5 mm  
Placa en trebol 3,5 mm

Art. Nr.	Lochzahl	Länge
Cat. No.	Holes	Length
Cat. No.	Agujeros	Longitud
82-200-00	3	88 mm
82-200-05	4	104 mm
82-200-10	5	120 mm
82-200-15	6	136 mm

# Kleinfragmentsortiment Set of Smallfragment Sortimento de fragmento pequeño

---

Rekonstruktionsplatte 3,5 mm  
Reconstruction plate 3,5 mm  
Placa de reconstruction 3,5 mm

Art. Nr. Cat. No. Cat. No.	Lochzahl Holes Agujeros	Länge Length Longitud
82-210-00	5	58 mm
82-210-05	6	70 mm
82-210-10	7	82 mm
82-210-15	8	94 mm
82-210-20	9	106 mm
82-210-25	10	118 mm
82-210-30	11	130 mm
82-210-35	12	142 mm
82-210-40	13	154 mm
82-210-45	14	166 mm
82-210-50	15	178 mm
82-210-55	16	190 mm
82-210-60	18	214 mm



Rekonstruktionsplatte gebogen 3,5 mm  
Reconstruction plate curved 3,5 mm  
Placa de reconstruction curva 3,5 mm

Art. Nr. Cat. No. Cat. No.	Lochzahl Holes Agujeros	Länge Length Longitud
82-220-00	6	70 mm
82-220-05	8	94 mm
82-220-10	10	118 mm
82-220-15	12	142 mm
82-220-20	14	166 mm
82-220-25	16	190 mm
82-220-30	18	214 mm



# Kleinfragmentsortiment

## Set of Smallfragment

### Sortimento de fragmento pequeño

---

#### Kleinfragment - Instrumentarium

#### Small Fragment - Instrumentation

#### Instrumentario para pequeño fragmento



82-230-00      Spiralbohrer mit Anschluß für Schnellkuppling  $\varnothing$  2,5 mm  
Drill bit with end to fit quick coupling  $\varnothing$  2,5 mm  
Broca con mango para acoplamiento rapido  $\varnothing$  2,5 mm

82-230-05      Spiralbohrer mit Rundschaft  $\varnothing$  2,5 mm  
Drill bit with round end  $\varnothing$  2,5 mm  
Broca con vastago redondo  $\varnothing$  2,5 mm



82-240-00      Spiralbohrer mit Anschluß für Schnellkuppling  $\varnothing$  3,5 mm  
Drill bit with end to fit quick coupling  $\varnothing$  3,5 mm  
Broca con mango para acoplamiento rapido  $\varnothing$  3,5 mm

82-240-05      Spiralbohrer mit Rundschaft  $\varnothing$  3,5 mm  
Drill bit with round end  $\varnothing$  3,5 mm  
Broca con vastago redondo  $\varnothing$  3,5 mm



82-250-00      Kleiner Kopfraumfräser - Einsatz  
Small Countersink  
Avellanador pequeño



82-260-00      Gewindeschneider  $\varnothing$  3,5 mm für Kortikalisschrauben, fein (**Steigung 1,25 mm**)  
Tap  $\varnothing$  3,5 mm for cortical screws, fine (**pitch 1,25 mm**)  
Macho  $\varnothing$  3,5 mm para tornillos corticales, fino (**paso de rosca 1,25 mm**)



82-270-00      Gewindeschneider  $\varnothing$  3,5 mm für Spongiaschrauben, grob (**Steigung 1,75 mm**)  
Tap  $\varnothing$  3,5 mm for Spongiosa screws, grob (**pitch 1,75 mm**)  
Macho  $\varnothing$  3,5 mm para tornillos espongiosa, grueso (**paso de rosca 1,75 mm**)

**Kleinfragment - Instrumentarium  
Small Fragment - Instrumentation  
Instrumentario para pequeño fragmento**



82-260-05 Gewindeschneider  $\varnothing$  3,5 mm für Kortikalisschrauben, fein (**Steigung 1,25 mm**) mit T - Griff  
Tap  $\varnothing$  3,5 mm for cortical screws, fine (**pitch 1,25 mm**) with T- Bar  
Macho  $\varnothing$  3,5 mm para tornillos corticales, fino (**paso de rosca 1,25 mm**) con mango en T

82-270-05 Gewindeschneider  $\varnothing$  3,5 mm für Spongiosaschrauben, grob (Steigung 1,75 mm) mit T - Griff  
Tap  $\varnothing$  3,5 mm for Spongiosa screws, grob (pitch 1,75 mm) with T - Bar  
Macho  $\varnothing$  3,5 mm para tornillos esponjosa, grueso (paso de rosca 1,75 mm) con mango en T



82-280-00 Handstück mit Schnellkuppung  
Tap Handle with quick coupling  
Mango de acoplamiento rapido



82-290-00 Griffstück für Gewindeschneider mit Schnellkupplung  
Handle for taps with quick coupling  
Mandril para machos de acoplamiento rapido

# Kleinfragmentsortiment

## Set of Smallfragment

### Sortimento de fragmento pequeño

---

#### Kleinfragment - Instrumentarium

#### Small Fragment - Instrumentation

#### Instrumentario para pequeño fragmento



82-300-00 Gewebeschutzhülse  $\varnothing$  3,5 mm / Bohrbüchse  $\varnothing$  2,5 mm  
Tap Sleeve  $\varnothing$  3,5 mm / Drill Sleeve  $\varnothing$  2,5 mm  
Guia conductora  $\varnothing$  3,5 mm / Guía de broca  $\varnothing$  2,5 mm



82-310-00 Steckbohrbüchse  $\varnothing$  3,5 mm /  $\varnothing$  2,5 mm  
Insert Drill Sleeve  $\varnothing$  3,5 mm /  $\varnothing$  2,5 mm  
Casquillo centrador  $\varnothing$  3,5 mm /  $\varnothing$  2,5 mm



82-320-00 Ziel - und Platten - Bohrbüchse  
Drill Guide and Drill Sleeve  
Guia conductora con 3 orificios



82-330-00 Neutral - und Spannbohrbüchse  $\varnothing$  3,5 mm für Bohrer  $\varnothing$  2,5 mm  
Neutral and Load Drill Guide  $\varnothing$  3,5 mm for Drill Bit  $\varnothing$  2,5 mm  
Guia de broca neutral y para tensión  $\varnothing$  3,5 mm para brocas 2,5 mm



**Kleinfragment - Instrumentarium**  
**Small Fragment - Instrumentation**  
**Instrumentario para pequeño fragmento**



82-340-00 Kleiner Schraubenzieher 6 - Kant, 2,5 mm SW  
Small Hexagonal screw Driver 2,5 mm  
Destornillador pequeño 2,5 mm



81-495-00 Haltehülse einzeln 2,5 mm  
Holding Sleeve 2,5 mm  
Pinza de sujecion 2,5 mm

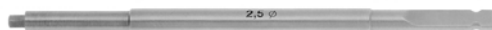

82-360-00 Kleiner Schraubenzieher - Einsatz 6 - Kant, 2,5 mm SW  
Small Hexagonal screw Driver 2,5 mm  
Atornillador pequeño 2,5 mm



82-370-00 Schraubenmeßgerät für kleine Schrauben  
Small Depth Gauge  
Medidor de profundidad pequeño

**Kleinfragmentsortiment**  
**Set of Smallfragment**  
**Sortimento de fragmento pequeño**

---

**Kleinfragment - Instrumentarium**  
**Small Fragment - Instrumentation**  
**Instrumentario para pequeño fragmento**

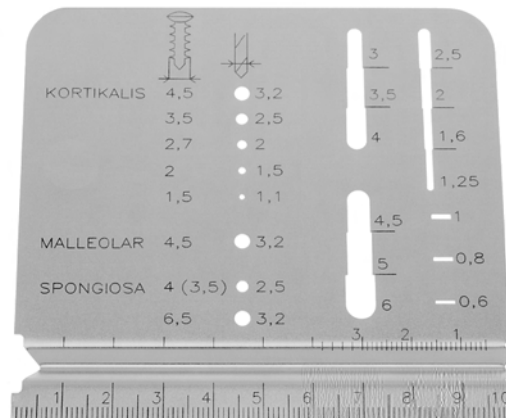

81-710-00 Messlehre für Schrauben  
Measuring Plate for screws  
Medidor para tornillos



82-390-00 Gabelschlüssel 11 mm SW  
Combination Wrench width across flats 11 mm  
Llave de 11 mm

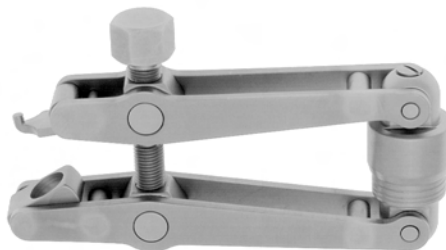

82-400-00 Plattenspanner mit Gelenken Spannweg 20 mm  
Articulated Tension Device with indicator span 20 mm  
Tensor de placas carrera 20 mm con charnela

**Kleinfragment - Instrumentarium**  
**Small Fragment - Instrumentation**  
**Instrumentario para pequeño fragmento**



81-720-00 Selbsthaltende Schraubenpinzette  
Screw Forceps selfholding  
Pinza fijadora



82-420-00 Universalbohrbüchse 3,5 mm mit Feder  
Drill Sleeve 3,5 mm with feather  
Guia de broca 3,5 mm con molle



82-430-00 Biegezange für kleine Platten und Draht (Spitzzange)  
Bending Pliers for small plates and wire  
Pinza dobladora para placas pequeñas y alambre



81-700-00 Biegebolzen für Kirschnerdrähte  
Bending Iron for Wire  
Barra dobladora

**Kleinfragmentsortiment**  
**Set of Smallfragment**  
**Sortimento de fragmento pequeño**

---

**Kleinfragment - Instrumentarium**  
**Small Fragment - Instrumentation**  
**Instrumentario para pequeño fragmento**



81-380-00 Scharfer Haken  
Sharp Hook  
Gancho agudo



82-460-00 Biegeschablonen  
Bending Temple  
Chablon para oblar



81-670-00 Schränkeisen  
Bending Iron for Small Plates  
Llave dobladora para placas pequeñas



81-670-10 Schränkeisen  
Bending Iron for Small Plates  
Llave dobladora para placas pequeñas



82-480-00 Biegezangen für kleine Plättchen  
Bending Pliers for Small Plates  
Tenaza dobladora para placas pequeñas

**Kleinfragment - Instrumentarium**  
**Small Fragment - Instrumentation**  
**Instrumentario para pequeño fragmento**



81-650-00 Selbstzentrierende Knochenhalte­zangen, Gewin­desperre Länge 150 mm  
Selfcentering Bone Holding Forceps  
Pinza de reduccion con bloque axial autocentrante



81-580-00 Repositionszange mit Spitzen  
Reduction forceps with points  
Pinza de reduccion con puntas



81-650-00 Repositionszange für Kleinfragmente  
Reduction forceps for Small fragment  
Pinza de reduccion para fragmentos pequeños

**Kleinfragmentsortiment**  
**Set of Smallfragment**  
**Sortimento de fragmento pequeño**

---

**Kleinfragment - Instrumentarium**  
**Small Fragment - Instrumentation**  
**Instrumentario para pequeño fragmento**



81-550-00

Kleiner Knochenheber 6 mm  
Small Retractor 6 mm  
Retractor pequeño 6 mm

81-550-10

Kleiner Knochenheber 8 mm  
Small Retractor 8 mm  
Retractor pequeño 8 mm



81-560-00

Knochenheber für Kleinfragmente  
Small Retractor  
Retractor pequeño



81-590-05

Raspatorium klein mit gerader Schneide 6 mm  
Periosteal Elevator small  
Elevador peristéal pequeño

**Kleinfragment - Instrumentarium**  
**Small Fragment - Instrumentation**  
**Instrumentario para pequeño fragmento**

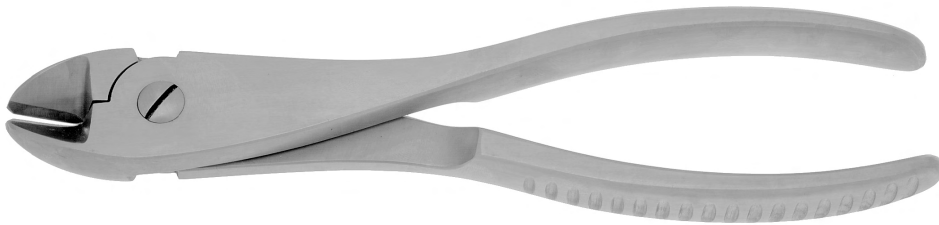

82-570-00 Drahtschneidezange groß  
Wire Cutter  
Alicate



82-580-00 Drahtschneidezange klein  
Wire Cutter  
Alicate

**Kleinfragmentsortiment**  
**Set of Smallfragment**  
**Sortimento de fragmento pequeño**

---











**Großfragmentsortiment**  
**Set of large fragments**  
**Sortimento de grandes fragmentos**

**Großfragmentsortiment**  
**Set of large fragments**  
**Sortimento de grandes fragmentos**

**Großfragment - Schrauben**  
**Large fragment Screws**  
**Tornillos para fragmentos grandes**

		
<p>Korticalisschrauben 4,5 mm            Cortical Screws 4,5 mm            Tornillos corticales 4,5 mm</p>	<p>Korticalisschrauben 4,5 mm mit Schaft            Cortical Screws 4,5 mm with shaft            Tornillos corticales 4,5 mm con caña</p>	<p>Malleolarschrauben 4,5 mm            Maleolar Screws 4,5 mm            Tornillos maleolares 4,5 mm</p>
<p>Gewindedurchmesser 4,5 mm            Kerndurchmesser 3,0 mm            Kopfdurchmesser 8,0 mm            Innensechskant 3,5 mm            Bohrer für Gewindeloch 3,2 mm            Bohrer für Gleichtloch 4,5 mm</p>	<p>Gewindedurchmesser 4,5 mm            Kerndurchmesser 3,1 mm            Schaftdurchmesser 4,5 mm            Kopfdurchmesser 8,0 mm            Innensechskant 3,5 mm            Bohrer für Gewindeloch 3,2 mm</p>	<p>Gewindedurchmesser 4,5 mm            Kerndurchmesser 3,0 mm            Schaftdurchmesser 3,0 mm            Kopfdurchmesser 8,0 mm            Innensechskant 3,5 mm            Bohrer für Gewindeloch 3,2 mm</p>
<p>Diameter of thread 4,5 mm            Diameter of core 3,0 mm            Diameter of head 8,0 mm            Imbus 3,5 mm            Drill bit for thread hole 3,2 mm            Drill bit for sliding hole 4,5 mm</p>	<p>Diameter of thread 4,5 mm            Diameter of core 3,1 mm            Diameter of shaft 4,5 mm            Diameter of head 8,0 mm            Imbus 3,5 mm            Drill bit for sliding hole 3,2 mm</p>	<p>Diameter of thread 4,5 mm            Diameter of core 3,0 mm            Diameter of shaft 3,0 mm            Diameter of head 8,0 mm            Imbus 3,5 mm            Drill bit for sliding hole 3,2 mm</p>
<p>Diametro de la rosca 4,5 mm            Diametro del nucleo 3,0 mm            Diametro de la cabeza 6,0 mm            Hexagono interior 3,5 mm            Broca para orificio de roscar 3,2 mm            Broca para orificio deslizante 4,5 mm</p>	<p>Diametro de la rosca 4,5 mm            Diametro del nucleo 3,1 mm            Diametro de caña 4,5 mm            Diametro de la cabeza 8,0 mm            Hexagono interior 3,5 mm            Broca para orificio deslizante 3,2 mm</p>	<p>Diametro de la rosca 4,5 mm            Diametro del nucleo 3,0 mm            Diametro de caña 3,0 mm            Diametro de la cabeza 8,0 mm            Hexagono interior 3,5 mm            Broca para orificio deslizante 3,2 mm</p>

**Großfragment - Schrauben**  
**Large fragment Screws**  
**Tornillos para fragmentos grandes**

		
Spongiosaschrauben 6,5 mm Spongiosal Screws 6,5 mm Tornillos esponjosa 6,5 mm	Spongiosaschrauben 6,5 mm Spongiosa Screws 6,5 mm Tornillos esponjosa 6,5 mm	Spongiosaschrauben 6,5 mm Spongiosa Screws 6,5 mm Tornillos esponjosa 6,5 mm
Gewindedurchmesser 6,5 mm Gewindelänge 16 mm Kerndurchmesser 3,0 mm Schaftdurchmesser 4,5 mm Kopfdurchmesser 8,0 mm Innensechskant 3,5 mm Bohrer für Gewindeloch 3,2 mm Bohrer für Schaft 4,5 mm	Gewindedurchmesser 6,5 mm Gewindelänge 32 mm Kerndurchmesser 3,0 mm Schaftdurchmesser 4,5 mm Kopfdurchmesser 8,0 mm Innensechskant 3,5 mm Bohrer für Gewindeloch 3,2 mm Bohrer für Schaft 4,5 mm	Gewindedurchmesser 6,5 mm Gewindelänge voll Kerndurchmesser 3,0 mm Schaftdurchmesser 4,5 mm Kopfdurchmesser 8,0 mm Innensechskant 3,5 mm Bohrer für Gewindeloch 3,2 mm Bohrer für Schaft 4,5 mm
Diameter of thread 6,5 mm Length of thread 16 mm Diameter of core 3,0 mm Diameter of shaft 4,5 mm Diameter of head 8,0 mm Imbus 3,5 mm Drill bit for thread hole 3,2 mm Drill bit for shaft 3,5 mm	Diameter of thread 6,5 mm Length of thread 32 mm Diameter of core 3,0 mm Diameter of shaft 4,5 mm Diameter of head 8,0 mm Imbus 3,5 mm Drill bit for thread hole 3,2 mm Drill bit for shaft 3,5 mm	Diameter of thread 6,5 mm Length of thread full Diameter of core 3,0 mm Diameter of shaft 4,5 mm Diameter of head 8,0 mm Imbus 3,5 mm Drill bit for thread hole 3,2 mm Drill bit for shaft 3,5 mm
Diametro de la rosca 6,5 mm Longitud de rosca 16 mm Diametro del nucleo 3,0 mm Diametro de caña 4,5 mm Diametro de la cabeza 8,0 mm Hexagono interior 3,5 mm Broca para orificio de roscar 3,2 mm Broca para caña 4,5 mm	Diametro de la rosca 6,5 mm Longitud de rosca 32 mm Diametro del nucleo 3,0 mm Diametro de caña 4,5 mm Diametro de la cabeza 8,0 mm Hexagono interior 3,5 mm Broca para orificio de roscar 3,2 mm Broca para caña 4,5 mm	Diametro de la rosca 6,5 mm Longitud de rosca entero Diametro del nucleo 3,0 mm Diametro de caña 4,5 mm Diametro de la cabeza 8,0 mm Hexagono interior 3,5 mm Broca para orificio de roscar 3,2 mm Broca para caña 4,5 mm

# Großfragmentsortiment

## Set of large fragments

### Sortimento de grandes fragmentos

#### Großfragment - Schrauben

#### Large fragment Screws

#### Tornillos para fragmentos grandes

Kortikalisschrauben 4,5 mm  
Cortical screws 4,5 mm  
Tornillos corticales 4,5 mm

Art. Nr. Cat. No. Cat. No.	Länge Length Longitud
83-100-00	14 mm
83-100-02	16 mm
83-100-04	18 mm
83-100-06	20 mm
83-100-08	22 mm
83-100-10	24 mm
83-100-12	26 mm
83-100-14	28 mm
83-100-16	30 mm
83-100-18	32 mm
83-100-20	34 mm
83-100-22	36 mm
83-100-24	38 mm
83-100-26	40 mm
83-100-28	42 mm
83-100-30	44 mm
83-100-32	46 mm
83-100-34	48 mm
83-100-36	50 mm
83-100-38	52 mm
83-100-40	54 mm
83-100-42	56 mm
83-100-44	58 mm
83-100-46	60 mm
83-100-48	62 mm
83-100-50	64 mm
83-100-52	66 mm
83-100-54	68 mm
83-100-56	70 mm



Kortikalisschrauben 4,5 mm  
Cortical Screws 4,5 mm  
Tornillos corticales 4,5 mm

Gewindedurchmesser 4,5 mm  
Kerndurchmesser 3,0 mm  
Kopfdurchmesser 8,0 mm  
Innensechskant 3,5 mm  
Bohrer für Gewindeloch 3,2 mm  
Bohrer für Gleitloch 4,5 mm

Diameter of thread 4,5 mm  
Diameter of core 3,0 mm  
Diameter of head 8,0 mm  
Imbus 3,5 mm  
Drill bit for thread hole 3,2 mm  
Drill bit for sliding hole 4,5 mm

Diametro de la rosca 4,5 mm  
Diametro del nucleo 3,0 mm  
Diametro de la cabeza 8,0 mm  
Hexagono interior 3,5 mm  
Broca para orificio de roscar 3,2 mm  
Broca para orificio deslizante 4,5 mm

Mutter zu 4,5 mm Kortikalisschraube  
Nut for 4,5 mm Cortex screw  
Arandella para tornillos de 4,5 mm



83-105-00

**Großfragment - Schrauben**  
**Large fragment Screws**  
**Tornillos para fragmentos grandes**

Kortikalisschrauben 4,5 mm mit Schaft  
 Cortical screws 4,5 mm with shaft  
 Tornillos corticales 4,5 mm con cuello

Corticalisschrauben 4,5 mm mit Schaft  
 Cortical Screws 4,5 mm with shaft  
 Tornillos corticales 4,5 mm con shaft

Art. Nr. Cat. No. Cat. No.	Länge Length Longitud
83-110-00	22 mm
83-110-02	24 mm
83-110-04	26 mm
83-110-06	28 mm
83-110-08	30 mm
83-110-10	32 mm
83-110-12	34 mm
83-110-14	36 mm
83-110-16	38 mm
83-110-18	40 mm
83-110-20	42 mm
83-110-22	44 mm
83-110-24	46 mm
83-110-26	48 mm
83-110-28	50 mm
83-110-30	52 mm
83-110-32	54 mm
83-110-34	56 mm
83-110-36	58 mm
83-110-38	60 mm
83-110-40	62 mm
83-110-42	64 mm
83-110-44	66 mm
83-110-46	68 mm
83-110-48	70 mm
83-110-50	75 mm
83-110-52	80 mm
83-110-54	85 mm
83-110-56	90 mm
83-110-58	95 mm
83-110-60	100 mm
83-110-62	105 mm
83-110-64	110 mm



Gewindedurchmesser	4,5 mm
Kerndurchmesser	3,1 mm
Schaftdurchmesser	4,5 mm
Kopfdurchmesser	8,0 mm
Innensechskant	3,5 mm
Bohrer für Gewindeloch	3,2 mm

Diameter of thread	4,5 mm
Diameter of core	3,1 mm
Diameter of shaft	4,5 mm
Diameter of head	8,0 mm
Imbus	3,5 mm
Drill bit for sliding hole	3,2 mm

Diametro de la rosca	4,5 mm
Diametro del nucleo	3,1 mm
Diametro de caña	4,5 mm
Diametro de la cabeza	8,0 mm
Hexagono interior	3,5 mm
Broca para orificio deslizante	3,2 mm

**Großfragmentsortiment**  
**Set of large fragments**  
**Sortimento de grandes fragmentos**

---

**Großfragment - Schrauben**  
**Large fragment Screws**  
**Tornillos para fragmentos grandes**

Malleolarschrauben 4,5 mm  
 Malleolar screws 4,5 mm  
 Tornillos maleolares 4,5 mm

Malleolarschrauben 4,5 mm  
 Maleolar Screws 4,5 mm  
 Tornillos maleolares 4,5 mm

Art. Nr.	Länge
Cat. No.	Length
Cat. No.	Longitud
83-120-00	20 mm
83-120-02	25 mm
83-120-04	30 mm
83-120-06	35 mm
83-120-08	40 mm
83-120-10	45 mm
83-120-12	50 mm
83-120-14	55 mm
83-120-16	60 mm
83-120-18	65 mm
83-120-20	70 mm
83-120-22	80 mm

Gewindedurchmesser	4,5 mm
Kerndurchmesser	3,0 mm
Schaftdurchmesser	3,0 mm
Kopfdurchmesser	8,0 mm
Innensechskant	3,5 mm
Bohrer für Gewindeloch	3,2 mm

Diameter of thread	4,5 mm
Diameter of core	3,0 mm
Diameter of shaft	3,0 mm
Diameter of head	8,0 mm
Imbus	3,5 mm
Drill bit for sliding hole	3,2 mm



Diametro de la rosca	4,5 mm
Diametro del nucleo	3,0 mm
Diametro de caña	3,0 mm
Diametro de la cabeza	8,0 mm
Hexagono interior	3,5 mm
Broca para orificio deslizante	3,2 mm

# Großfragmentsortiment Set of large fragments Sortimento de grandes fragmentos

## Großfragment - Schrauben Large fragment Screws Tornillos para fragmentos grandes

Spongiaschrauben 6,5 mm Gewindelänge 16 mm  
Malleolar screws 4,5 mm Length of thread 16 mm  
Tornillos maleolares 4,5 mm longitud de rosca 16 mm

Spongiaschrauben 6,5 mm  
Spongiosal Screws 6,5 mm  
Tornillos esponjiosa 6,5 mm

Art. Nr. Cat. No. Cat. No.	Länge Length Longitud
83-130-00	25 mm
83-130-02	30 mm
83-130-04	35 mm
83-130-06	40 mm
83-130-08	45 mm
83-130-10	50 mm
83-130-12	55 mm
83-130-14	60 mm
83-130-16	65 mm
83-130-18	70 mm
83-130-20	75 mm
83-130-22	80 mm
83-130-24	85 mm
83-130-26	90 mm
83-130-28	95 mm
83-130-30	100 mm
83-130-32	105 mm
83-130-34	110 mm

Gewindedurchmesser	6,5 mm
Gewindelänge	16 mm
Kerndurchmesser	3,0 mm
Schaftdurchmesser	4,5 mm
Kopfdurchmesser	8,0 mm
Innensechskant	3,5 mm
Bohrer für Gewindeloch	3,2 mm
Bohrer für Schaft	4,5 mm

Diameter of thread	6,5 mm
Length of thread	16 mm
Diameter of core	3,0 mm
Diameter of shaft	4,5 mm
Diameter of head	8,0 mm
Imbus	3,5 mm
Drill bit for thread hole	3,2 mm
Drill bit for shaft	3,5 mm

Diametro de la rosca	6,5 mm
Longitud de rosca	16 mm
Diametro del nucleo	3,0 mm
Diametro de caña	4,5 mm
Diametro de la cabeza	8,0 mm
Hexagono interior	3,5 mm
Broca para orificio de roscar	3,2 mm
Broca para caña	4,5 mm



# Großfragmentsortiment

## Set of large fragments

### Sortimento de grandes fragmentos

#### Großfragment - Schrauben

#### Large fragment Screws

#### Tornillos para fragmentos grandes

Spongiosaschrauben 6,5 mm Gewindelänge 16 mm  
 Malleolar screws 4,5 mm Length of thread 16 mm  
 Tornillos maleolares 4,5 mm longitud de rosca 16 mm

Spongiosaschrauben 6,5 mm  
 Spongiosa Screws 6,5 mm  
 Tornillos espojiosa 6,5 mm

Art. Nr.	Länge
Cat. No.	Length
Cat. No.	Longitud
83-140-00	35 mm
83-140-02	40 mm
83-140-04	45 mm
83-140-06	50 mm
83-140-08	55 mm
83-140-10	60 mm
83-140-12	65 mm
83-140-14	70 mm
83-140-16	75 mm
83-140-18	80 mm
83-140-20	85 mm
83-140-22	90 mm
83-140-24	95 mm
83-140-26	100 mm
83-140-28	105 mm
83-140-30	110 mm



Gewindedurchmesser	6,5 mm
Gewindelänge	32 mm
Kerndurchmesser	3,0 mm
Schaftdurchmesser	4,5 mm
Kopfdurchmesser	8,0 mm
Innensechskant	3,5 mm
Bohrer für Gewindeloch	3,2 mm
Bohrer für Schaft	4,5 mm

Diameter of thread	6,5 mm
Length of thread	32 mm
Diameter of core	3,0 mm
Diameter of shaft	4,5 mm
Diameter of head	8,0 mm
Imbus	3,5 mm
Drill bit for thread hole	3,2 mm
Drill bit for shaft	3,5 mm

Diametro de la rosca	6,5 mm
Longitud de rosca	32 mm
Diametro del nucleo	3,0 mm
Diametro de caña	4,5 mm
Diametro de la cabeza	8,0 mm
Hexagono interior	3,5 mm
Broca para orificio de roscar	3,2 mm
Broca para caña	4,5 mm



# Großfragmentsortiment Set of large fragments Sortimento de grandes fragmentos

## Großfragment - Schrauben Large fragment Screws Tornillos para fragmentos grandes

Spongiosaschrauben 6,5 mm Vollgewinde  
Malleolar screws 4,5 mm full threaded  
Tornillos maleolares 4,5 mm rosca entera

Art. Nr. Cat. No Cat. No	Länge Length Longitud
83-150-00	25 mm
83-150-02	30 mm
83-150-04	35 mm
83-150-06	40 mm
83-150-08	45 mm
83-150-10	50 mm
83-150-12	55 mm
83-150-14	60 mm
83-150-16	65 mm
83-150-18	70 mm
83-150-20	75 mm
83-150-22	80 mm
83-150-24	85 mm
83-150-26	90 mm
83-150-28	95 mm
83-150-30	100 mm
83-150-32	105 mm
83-150-34	110 mm



Spongiosaschrauben 6,5 mm  
Spongiosa Screws 6,5 mm  
Tornillos esponjosa 6,5 mm

Gewindedurchmesser	6,5 mm
Gewindelänge	voll
Kerndurchmesser	3,0 mm
Schaftdurchmesser	4,5 mm
Kopfdurchmesser	8,0 mm
Innensechskant	3,5 mm
Bohrer für Gewindeloch	3,2 mm
Bohrer für Schaft	4,5 mm

Diameter of thread	6,5 mm
Length of thread	full
Diameter of core	3,0 mm
Diameter of shaft	4,5 mm
Diameter of head	8,0 mm
Imbus	3,5 mm
Drill bit for thread hole	3,2 mm
Drill bit for shaft	3,5 mm

Diametro de la rosca	6,5 mm
Longitud de rosca	entero
Diametro del nucleo	3,0 mm
Diametro de caña	4,5 mm
Diametro de la cabeza	8,0 mm
Hexagono interior	3,5 mm
Broca para orificio de roscar	3,2 mm
Broca para caña	4,5 mm

Unterlagsscheibe  
Washer  
Arandella



83-155-00	ø 11,0 mm
83-155-10	ø 13,0 mm

**Großfragmentsortiment**  
**Set of large fragments**  
**Sortimento de grandes fragmentos**

---

**Schmale und breite Kompressionsplatten**  
**Narrow and broad Compression Plates**  
**Placas estrechas y anchas de compression**



**Schmale Kompressionsplatte**  
**Narrow Dynamic Plate**  
**Placa dinamica estrecha**

Art. Nr. Cat. No. Cat. No.	Länge Length Longitud	Löcher Holes Agujeros	Art. Nr. Cat. No. Cat. No.	Länge Length Longitud	Löcher Holes Agujeros
83-160-00	39 mm	2	83-160-16	167 mm	10
83-160-02	55 mm	3	83-160-18	183 mm	11
83-160-04	71 mm	4	83-160-20	194 mm	12
83-160-06	87 mm	5	83-160-22	215 mm	13
83-160-08	103 mm	6	83-160-24	231 mm	14
83-160-10	114 mm	7	83-160-26	247 mm	15
83-160-12	135 mm	8	83-160-28	263 mm	16
83-160-14	151 mm	9	83-160-30	289 mm	18



**Breite Kompressionsplatte**  
**Broad Dynamic Plate**  
**Placa dinamica ancha**

Art. Nr. Cat. No. Cat. No.	Länge Length Longitud	Löcher Holes Agujeros	Art. Nr. Cat. No. Cat. No.	Länge Length Longitud	Löcher Holes Agujeros
83-170-00	103 mm	6	83-170-12	199 mm	12
83-170-02	119 mm	7	83-170-14	215 mm	13
83-170-04	135 mm	8	83-170-16	231 mm	14
83-170-06	151 mm	9	83-170-18	247 mm	15
83-170-08	167 mm	10	83-170-20	263 mm	16
83-170-10	183 mm	11	83-170-22	295 mm	18

**Schmale und breite Verlängerungsplatten**  
**Narrow and broad Lengthening Plates**  
**Placas de elongacion estrechas y anchas**



**Schmale Verlängerungsplatte mit 8 Löchern**  
**Narrow Lengthening Plate with 8 holes**  
**Placa de elongacion estrecha con 8 agujeros**

Art. Nr. Cat. No. Cat. No.	Verlängerung Amount of lengthening Elongacion	Länge Lentgh Longitud	Art. Nr. Cat. No. Cat. No.	Verlängerung Amount of lengthening Elongacion	Länge Lentgh Longitud
83-180-00	30 mm	135 mm	83-180-06	60 mm	165 mm
83-180-02	40 mm	145 mm	83-180-08	70 mm	175 mm
83-180-04	50 mm	155 mm	83-180-10	80 mm	185 mm



**Breite Verlängerungsplatte mit 8 Löchern**  
**Broad Lengthening Plate with 8 holes**  
**Placa de elongacion ancha con 8 agujeros**

Art. Nr. Cat. No. Cat. No.	Verlängerung Amount of lengthening Elongacion	Länge Lentgh Longitud	Art. Nr. Cat. No. Cat. No.	Verlängerung Amount of lengthening Elongacion	Länge Lentgh Longitud
83-190-00	30 mm	135 mm	83-190-04	50 mm	155 mm
83-190-02	40 mm	145 mm	83-190-06	60 mm	165 mm

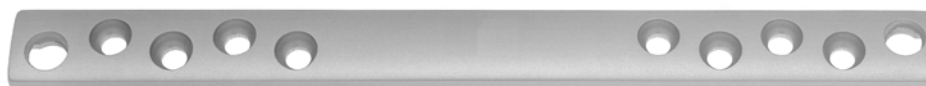

**Breite Verlängerungsplatte mit 10 Löchern**  
**Broad Lengthening Plate with 10 holes**  
**Placa de elongacion ancha con 10 agujeros**

Art. Nr. Cat. No. Cat. No.	Verlängerung Amount of lengthening Elongacion	Länge Lentgh Longitud	Art. Nr. Cat. No. Cat. No.	Verlängerung Amount of lengthening Elongacion	Länge Lentgh Longitud
83-200-00	50 mm	135 mm	83-200-08	90 mm	155 mm
83-200-02	60 mm	145 mm	83-200-10	100 mm	155 mm
83-200-04	70 mm	145 mm	83-200-12	110 mm	165 mm
83-200-06	80 mm	145 mm	83-200-14	120 mm	145 mm

# Großfragmentsortiment

## Set of large fragments

### Sortimento de grandes fragmentos

#### Formplatten Form Plates Placas de formas especiales

T - Abstützplatten für Schrauben 4,5 mm  
T - Butress Plate for screws 4,5 mm  
Placa de sosten en T para tornillos 4,5 mm

Art. Nr.	Länge	Löcher
Cat. No.	Length	Holes
Cat. No.	Longitud	Agujeros
83-210-00	80 mm	4
83-210-02	103 mm	5
83-210-04	116 mm	6



T - Platten für Schrauben 4,5 mm  
T - Plate for screws 4,5 mm  
Placa en forma de T para tornillos 4,5 mm

Art. Nr.	Länge	Löcher
Cat. No.	Length	Holes
Cat. No.	Longitud	Agujeros
83-220-00	68 mm	3
83-220-02	84 mm	4
83-220-04	100 mm	5
83-220-06	116 mm	6
83-220-08	148 mm	8
83-220-10	164 mm	9



L - Abstützplatten für Schrauben 4,5 mm  
L - Butress Plate for screws 4,5 mm  
Placa de sosten en L para tornillos 4,5 mm

Art. Nr.	Länge	Löcher
Cat. No.	Length	Holes
Cat. No.	Longitud	Agujeros
83-230-00	69 mm	4 links
83-235-00	69 mm	4 rechts
83-230-02	85 mm	4 links
83-235-02	85 mm	4 rechts
83-230-04	101 mm	4 links
83-235-04	101 mm	4 rechts
83-230-06	117 mm	4 links
83-235-06	117 mm	4 rechts



Löffelplatten für Schrauben 4,5 mm  
Spoon Plate for screws 4,5 mm  
Placa cuchara para tornillos 4,5 mm

Art. Nr.	Länge	Löcher
Cat. No.	Length	Holes
Cat. No.	Longitud	Agujeros
83-240-00	100 mm	5
83-240-10	120 mm	6

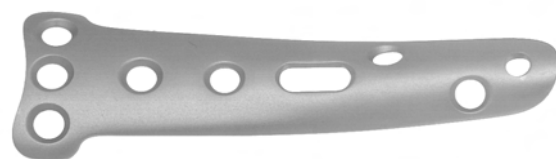

**Formplatten**  
**Form Plates**  
**Placas de formas especiales**



**Rekonstruktionsplatten gerade (für Schrauben 4,5 mm)**  
**Reconstructions Plate straight (for 4,5 mm screws)**  
**Placa de reconstruccion recta (para tornillos de 4,5 mm)**

Art. Nr. Cat. No. Cat. No.	Länge Length Longitud	Löcher Holes Agujeros	Art. Nr. Cat. No. Cat. No.	Länge Length Longitud	Löcher Holes Agujeros
83-250-00	45 mm	3	83-250-14	157 mm	10
83-250-02	61 mm	4	83-250-16	173 mm	11
83-250-04	77 mm	5	83-250-18	189 mm	12
83-250-06	93 mm	6	83-250-20	205 mm	13
83-250-08	109 mm	7	83-250-22	221 mm	14
83-250-10	125 mm	8	83-250-24	237 mm	15
83-250-12	141 mm	9	83-250-26	253 mm	16



**Rekonstruktionsplatten gebogen (für Schrauben 4,5 mm)**  
**Reconstructions Plate curved (for screws 4,5 mm)**  
**Placa de reconstruccion curva (para tornillos de 4,5 mm)**

Art. Nr. Cat. No. Cat. No.	Länge Length Longitud	Löcher Holes Agujeros
83-260-00	61 mm	4
83-260-02	93 mm	6
83-260-04	125 mm	8
83-260-06	157 mm	10
83-260-08	189 mm	12
83-260-10	221 mm	14
83-260-12	253 mm	16

**Formplatten**  
**Form Plates**  
**Placas de formas especiales**



**Halbrohrplatten (für Schrauben 4,5 mm)**  
**Semi tubular Plate (for screws 4,5 mm)**  
**Placa medio de tubo (para tornillos de 4,5 mm)**

Art. Nr. Cat. No. Cat. No.	Länge Length Longitud	Löcher Holes Agujeros	Art. Nr. Cat. No. Cat. No.	Länge Length Longitud	Löcher Holes Agujeros
83-270-00	39 mm	2	83-270-12	135 mm	8
83-270-02	55 mm	3	83-270-14	151 mm	9
83-270-04	71 mm	4	83-270-16	167 mm	10
83-270-06	87 mm	5	83-270-18	183 mm	11
83-270-08	103 mm	6	83-270-20	199 mm	12
83-270-10	119 mm	7			

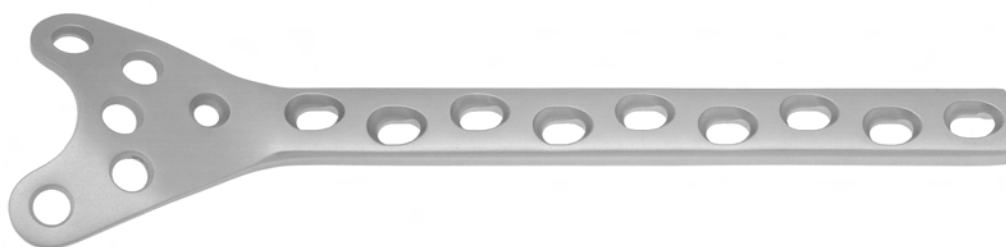

**Kondylenabstützplatte für Schrauben 4,5 mm**  
**Condylar Butress Plate for screws 4,5 mm**  
**Placa de sosten condilar para tonillos 4,5 mm**

Art. Nr. Cat. No. Cat. No.	Länge Length Longitud	Löcher Holes Agujeros	Art. Nr. Cat. No. Cat. No.	Länge Length Longitud	Löcher Holes Agujeros
83-280-00	158 mm	7 links	83-285-00	158 mm	7 rechts
83-280-02	190 mm	9 links	83-285-02	190 mm	9 rechts
83-280-04	221 mm	11 links	83-285-04	221 mm	11 rechts
83-280-06	253 mm	13 links	83-285-06	253 mm	13 rechts
83-280-08	285 mm	15 links	83-285-08	285 mm	15 rechts

**Formplatten**  
**Form Plates**  
**Placas de formas especiales**



**Kreuzplatte für Schrauben 4,5 mm und 6,5 mm**  
**Cobra Head Plate for screws 4,5 mm and 6,5 mm**  
**Placa Cobra para tornillos 4,5 mm y 6,5 mm**

Art. Nr. Cat. No. Cat. No.	Länge Length Longitud	Löcher Holes Agujeros	Art. Nr. Cat. No. Cat. No.	Länge Length Longitud	Löcher Holes Agujeros
83-290-00	170 mm	8	83-290-04	202 mm	10
83-290-02	186 mm	9	83-290-06	218 mm	11



**Laterale Tibiakopf - Abstützplatte für Schrauben 4,5 mm und 6,5 mm**  
**Lateral Tibia Head Plate for screws 4,5 and 6,5 mm**  
**Placa de sosten lateral para tornillos de 4,5 y 6,5 mm**

Art. Nr. Cat. No. Cat. No.	Länge Length Longitud	Löcher Holes Agujeros	Art. Nr. Cat. No. Cat. No.	Länge Length Longitud	Löcher Holes Agujeros
83-300-00	158 mm	5 links	83-305-00	158 mm	5 rechts
83-300-02	190 mm	7 links	83-305-02	190 mm	7 rechts
83-300-04	221 mm	9 links	83-305-04	221 mm	9 rechts
83-300-06	253 mm	11 links	83-305-06	253 mm	11 rechts
83-300-08	285 mm	13 links	83-305-08	285 mm	13 rechts

**Anatomische Knochenplatten  
 Anatomical Bone Plates  
 Placas anatomicas**

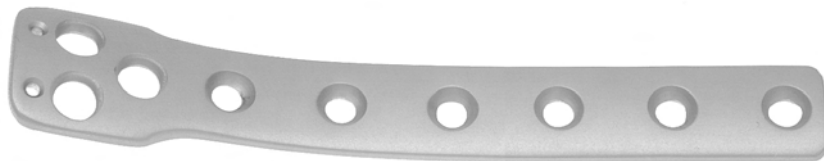

**Distal Tibia Platte  
 Distal Tibia Plate  
 Placa Distal para Tibia**

Art. Nr. Cat. Nr. Cat. Nr.	Länge Length Longitud	Löcher Holes Agujeros	Art. Nr. Cat. Nr. Cat. Nr.	Länge Length Longitud	Löcher Holes Agujeros
83-310-00	122 mm	7 links	83-315-00	122 mm	7 rechts
83-310-02	158 mm	9 links	83-315-02	158 mm	9 rechts
83-310-04	194 mm	11 links	83-315-04	194 mm	11 rechts
83-310-06	230 mm	13 links	83-315-06	230 mm	13 rechts

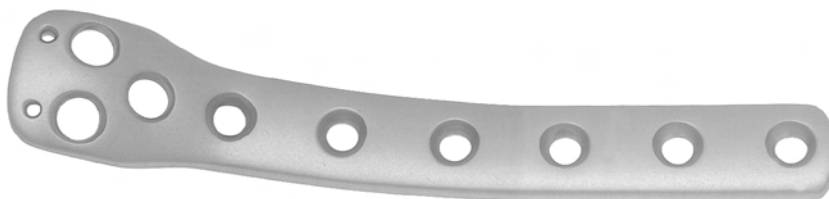

**Proximal Tibia Platte  
 Proximal Tibia Plate  
 Placa Proximal para Tibia**

Art. Nr. Cat. Nr. Cat. Nr.	Länge Length Longitud	Löcher Holes Agujeros	Art. Nr. Cat. Nr. Cat. Nr.	Länge Length Longitud	Löcher Holes Agujeros
83-320-00	122 mm	7 links	83-325-00	122 mm	7 rechts
83-320-02	158 mm	9 links	83-325-02	158 mm	9 rechts
83-320-04	194 mm	11 links	83-325-04	194 mm	11 rechts
83-320-06	230 mm	13 links	83-325-06	230 mm	13 rechts

---



**Anatomische Knochenplatten  
Anatomical Bone Plates  
Placas anatomicas**



**Distal Femur Platte  
Distal Femur Plate  
Placa Distal para Femur**

Art. Nr. Cat. Nr. Cat. Nr.	Länge Length Longitud	Löcher Holes Agujeros	Art. Nr. Cat. Nr. Cat. Nr.	Länge Length Longitud	Löcher Holes Agujeros
83-330-00	122 mm	7 links	83-335-00	122 mm	7 rechts
83-330-02	158 mm	9 links	83-335-02	158 mm	9 rechts
83-330-04	194 mm	11 links	83-335-04	194 mm	11 rechts
83-330-06	230 mm	13 links	83-335-06	230 mm	13 rechts



**Distal Tibia Platte für Fibula  
Distal Tibia Plate for Fibulae  
Placa Distal Tibia para Fibula**

Art. Nr. Cat. Nr. Cat. Nr.	Länge Length Longitud	Löcher Holes Agujeros	Art. Nr. Cat. Nr. Cat. Nr.	Länge Length Longitud	Löcher Holes Agujeros
83-340-00	122 mm	7 links	83-345-00	122 mm	7 rechts
83-340-02	158 mm	9 links	83-345-02	158 mm	9 rechts
83-340-04	194 mm	11 links	83-345-04	194 mm	11 rechts
83-340-06	230 mm	13 links	83-345-06	230 mm	13 rechts

**Großfragmentsortiment**  
**Set of large fragments**  
**Sortimento de grandes fragmentos**

---

**Dynamische Hüftschraubenplatte mit Standard Zylinder 38 mm**  
**Dynamic Hip Screw Plate with standard cilinder 38 mm**  
**Placa de compresion dinamica para cadera con cilindro standard 38 mm**

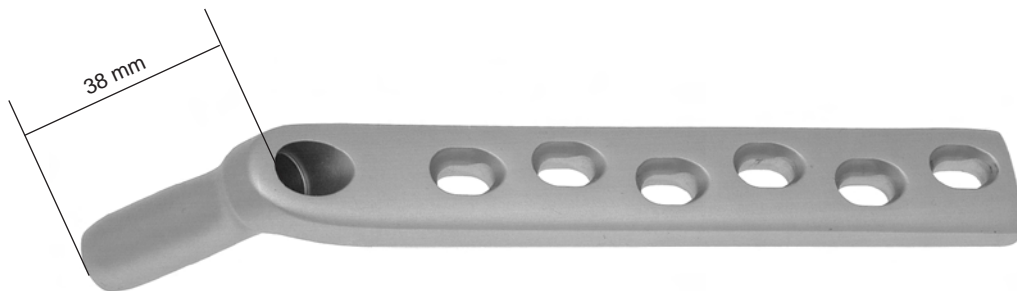

Hüftschraubenplatte 135°  
 Dynamic Hip Screw Plate 135°  
 Placa dinamica para cadera 135°

Art. Nr.	Löcher
Cat. No.	Holes
Cat. No.	Agujeros

83-350-00	2
83-350-02	4
83-350-04	5
83-350-06	6
83-350-08	8
83-350-10	10
83-350-12	12
83-350-14	14

Hüftschraubenplatte 140°  
 Dynamic Hip Screw Plate 140°  
 Placa dinamica para cadera 140°

Art. Nr.	Löcher
Cat. No.	Holes
Cat. No.	Agujeros

83-360-00	2
83-360-02	4
83-360-04	5
83-360-06	6
83-360-08	8
83-360-10	10
83-360-12	12
83-360-14	14

Hüftschraubenplatte 145°  
 Dynamic Hip Screw Plate 145°  
 Placa dinamica para cadera 145°

Art. Nr.	Löcher
Cat. No.	Holes
Cat. No.	Agujeros

83-370-00	2
83-370-02	4
83-370-04	5
83-370-06	6
83-370-08	8
83-370-10	10
83-370-12	12
83-370-14	14

Hüftschraubenplatte 150°  
 Dynamic Hip Screw Plate 150°  
 Placa dinamica para cadera 150°

Art. Nr.	Löcher
Cat. No.	Holes
Cat. No.	Agujeros

83-380-00	2
83-380-02	4
83-380-04	5
83-380-06	6
83-380-08	8
83-380-10	10
83-380-12	12
83-380-14	14

**Dynamische Hüftschraubenplatte mit kurzem Zylinder 25 mm**  
**Dynamic Hip Screw Plate with short cilinder 25 mm**  
**Placa de compresion dinamica para cadera con cilindro corto 25 mm**



Hüftschraubenplatte 135°  
 Dynamic Hip Screw Plate 135°  
 Placa dinamica para cadera 135°

Art. Nr.	Löcher
Cat. No.	Holes
Cat. No.	Agujeros
83-400-00	2
83-400-02	4
83-400-04	5
83-400-06	6
83-400-08	8
83-400-10	10
83-400-12	12
83-400-14	14

Hüftschraubenplatte 140°  
 Dynamic Hip Screw Plate 140°  
 Placa dinamica para cadera 140°

Art. Nr.	Löcher
Cat. No.	Holes
Cat. No.	Agujeros
83-410-00	2
83-410-02	4
83-410-04	5
83-410-06	6
83-410-08	8
83-410-10	10
83-410-12	12
83-410-14	14

Hüftschraubenplatte 145°  
 Dynamic Hip Screw Plate 145°  
 Placa dinamica para cadera 145°

Art. Nr.	Löcher
Cat. No.	Holes
Cat. No.	Agujeros
83-420-00	2
83-420-02	4
83-420-04	5
83-420-06	6
83-420-08	8
83-420-10	10
83-420-12	12
83-420-14	14

Hüftschraubenplatte 150°  
 Dynamic Hip Screw Plate 150°  
 Placa dinamica para cadera 150°

Art. Nr.	Löcher
Cat. No.	Holes
Cat. No.	Agujeros
83-430-00	2
83-430-02	4
83-430-04	5
83-430-06	6
83-430-08	8
83-430-10	10
53-430-12	12
83-430-14	14

**Großfragmentsortiment**  
**Set of large fragments**  
**Sortimento de grandes fragmentos**

---

**Kondylenschraubenplatte 95°**  
**Dynamic Condylar Screw Plate 95°**  
**Placa de compresion dinamica condylar para cadera 95 °**

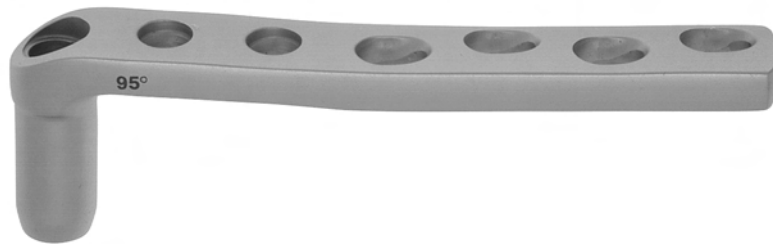

Zylinderlänge 25 mm. Zur Fixation mit Schrauben  $\varnothing$  4,5 und 6,5 mm  
Length of barrel 25 mm. For Fixation with Screws  $\varnothing$  4, 5 mm and 6,5 mm  
Longitud de tambor 25 mm. Para fijacion con tornillos  $\varnothing$  4,5 y 6,5 mm

Art. Nr.	Löcher
Cat. No.	Holes
Cat. No.	Agujeros
83-450-00	6
83-450-02	8
83-450-04	10
83-450-06	12
83-450-08	14
83-450-10	16



Kompressionsschraube  
Compression Screws  
Tornillo de compresion

Art. Nr.	Länge
Cat. No.	Length
Cat. No.	Longitud
83-460-00	50 mm

# Großfragmentsortiment Set of large fragments Sortimento de grandes fragmentos

---



Zugschraube  
Dynamic Compressions Screws  
Tornillo deslizante

Art. Nr. Cat. No. Cat. No.	Länge Length Longitud	Art. Nr. Cat. No. Cat. No.	Länge Length Longitud
83-470-00	50 mm	83-470-20	100 mm
83-470-02	55 mm	83-470-22	105 mm
83-470-04	60 mm	83-470-24	110 mm
83-470-06	65 mm	83-470-26	115 mm
83-470-08	70 mm	83-470-28	120 mm
83-470-10	75 mm	83-470-30	125 mm
83-470-12	80 mm	83-470-32	130 mm
83-470-14	85 mm	83-470-34	135 mm
83-470-16	90 mm	83-470-36	140 mm
83-470-18	95 mm	83-470-38	145 mm



Zugschraube selbstschneidend  
Dynamic Compressions Screws self tapping  
Tornillo deslizante autoroscante

Art. Nr. Cat. No. Cat. No.	Länge Length Longitud	Art. Nr. Cat. No. Cat. No.	Länge Length Longitud
83-475-00	50 mm	83-475-20	100 mm
83-475-02	55 mm	83-475-22	105 mm
83-475-04	60 mm	83-475-24	110 mm
83-475-06	65 mm	83-475-26	115 mm
83-475-08	70 mm	83-475-28	120 mm
83-475-10	75 mm	83-475-30	125 mm
83-475-12	80 mm	83-475-32	130 mm
83-475-14	85 mm	83-475-34	135 mm
83-475-16	90 mm	83-475-36	140 mm
83-475-18	95 mm	83-475-38	145 mm

**Großfragmentsortiment**  
**Set of large fragments**  
**Sortimento de grandes fragmentos**

---

**Instrumentarium nur für DHS**  
**Instrumentation only for DHS**  
**Instrumentario solo para DHS**

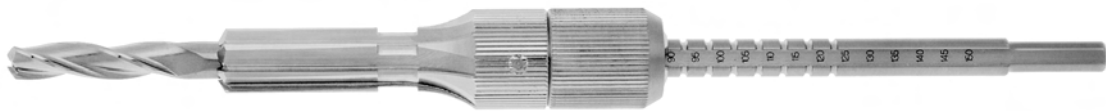

83-480-00 Dreistufenbohrer für Hüftschaube  
Triple Reamer, complete  
Fresa triple, completa

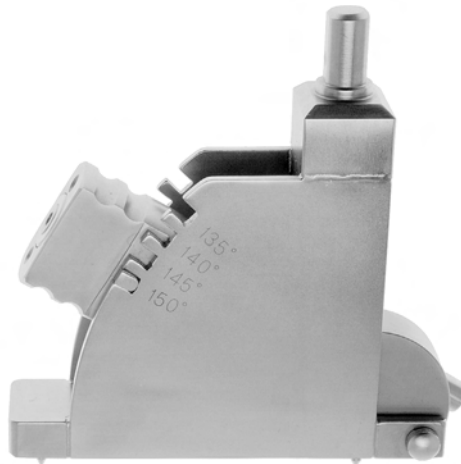

83-485-00 Zielgerät kombiniert 135° - 150°  
Drill Guide combined 135° - 150°  
Ajustador de angulos combinado 135° - 145°

Instrumentarium nur für DCS  
Instrumentation only for DCS  
Instrumentario solo para DCS



83-490-00 Dreistufenbohrer, komplet  
Triple Reamer, complete  
Fresa triple, completa



83-495-00 Zielgerät  
Drill Guide  
Ajustador de angulo

**Großfragmentsortiment**  
**Set of large fragments**  
**Sortimento de grandes fragmentos**

---

**Instrumentarium für DHS und DCS**  
**Instrumentation for DHS and DCS**  
**Instrumentario para DHS y DCS**



83-500-00 Führungsschaft zu Verbindungsschraube  
Guide Shaft for insertion of coupling Screws  
Guia para acoplar el tornillo



83-505-00 Verbindungsschraube  
Guide Shaft  
Tornillo de enlace



83-510-00 Lange Verbindungsschraube (nur zur Entfernung)  
Coupling Screw for Femoral Dynamic Hip Screw  
Pieza saca tornillos

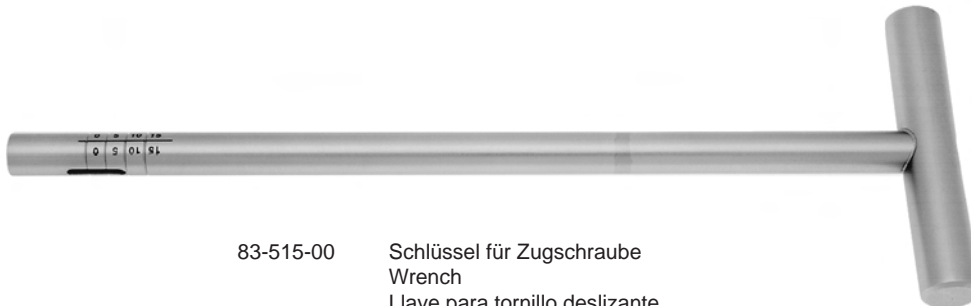

83-515-00 Schlüssel für Zugschraube  
Wrench  
Llave para tornillo deslizante



83-520-00 Einschlagbolzen  
Impactor  
Impactor



83-525-00 Führungsdraht mit Gewindespitze  $\varnothing$  2,5 mm Länge 230 mm  
Calibrated Threaded Guide Pin  $\varnothing$  2,5 mm, 230 mm Length, 10 mm Thread  
Guía calibrada con rosca  $\varnothing$  2,5 mm, longitud 230 mm, 10 mm de rosca



**Instrumentarium für DHS und DCS**  
**Instrumentation for DHS and DCS**  
**Instrumentario para DHS y DCS**



83-530-00    Messtab  
Measuring Gauge  
Medidor



83-535-00    Gewindeschneider  
Tap  
Macho

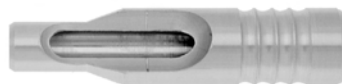

83-540-00    Zentrierhülse für Gewindeschneider  
Guide Sleeve, short, for tapping  
Guia centradora, corta



83-545-00    Zentrierhülse für Schlüssel  
Guide Sleeve, long for screwing in of the traction screws  
Guia centradora para llave



83-550-00    T - Handgriff mit Schnellkupplung  
Handle  
Mango en T con acoplamiento rapido

# Großfragmentsortiment

## Set of large fragments

### Sortimento de grandes fragmentos

---

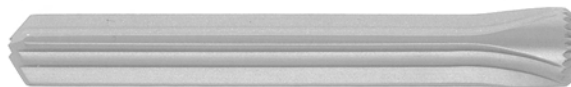

Smith - Peterson Nagel  
Smith Peterson Nails  
Clavo de Smith Peterson

60 mm 83-560-00	65 mm 83-560-02	70 mm 83-560-04	75 mm 83-560-06	80 mm 83-560-08	85 mm 83-560-10	90 mm 83-560-12	95 mm 83-560-14
100 mm 83-560-16	105 mm 83-560-18	110 mm 83-560-20	115 mm 83-560-22	120 mm 83-560-24	125 mm 83-560-26	130 mm 83-560-28	135 mm 83-560-30
140 mm 83-560-32	145 mm 83-560-34						



Mc Laughlin Platten  
Mc Laughlin Plate  
Placa Mc Laughlin

Art. Nr. Cat. No. Cat. No.	Löcher Holes Agujeros
83-570-00	3
83-570-02	5
83-570-04	7
83-570-06	12



83-580-00 Komponenten zur Verschraubung des Nagels mit der Platte  
Components for screwing Nail with Plate  
Componentes para atornillar el clavo con la placa

**Instrumentarium für Smith Peterson und Mc Laughlin  
Instrumentation for Smith Peterson and Mc Laughlin  
Instrumentario para Smith Peterson y Mc Laughlin**



83-585-00    Einschläger  
Nailstarter  
Impactor Guia

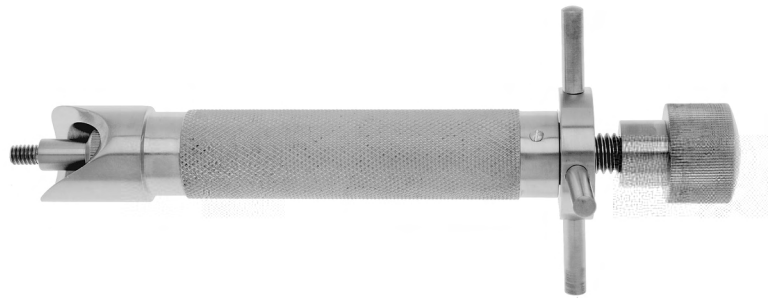

83-590-00    Einschläger Ausschläger Lloyd  
Impactor Extractor Lloyd  
Impactor Extractor Lloyd



83-595-00    Einschläger Ausschläger  
Impactor Extractor  
Impactor Extractor



83-600-00    Nagelführer  
Nail Driver  
Empujador - Impactor

# Großfragmentsortiment

## Set of large fragments

### Sortimento de grandes fragmentos

---

#### Jewett Nagelplatte 135°

#### Jewett Nail Plate 135°

#### Clavo placa Jewett 135°

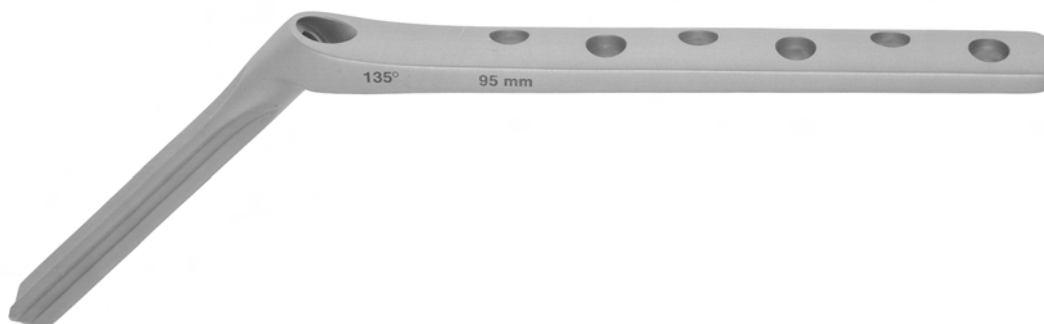

**3 Loch Plattenlänge: 90 mm**

**3 holes Length of plate: 90 mm**

**3 agujeros Longitud de placa: 90 mm**

**Nagellänge • Nail length • Longitud de clavo**

57 mm	63 mm	70 mm	76 mm	82 mm	89 mm	95 mm	102 mm	108 mm	114 mm	121 mm
83-610-00	83-610-05	83-610-10	83-610-15	83-610-20	83-610-25	83-610-30	83-610-35	83-610-40	83-610-45	83-610-50

**5 Loch Plattenlänge: 130 mm**

**5 holes Length of plate: 130 mm**

**5 agujeros Longitud de placa: 130 mm**

**Nagellänge • Nail length • Longitud de clavo**

57 mm	63 mm	70 mm	76 mm	82 mm	89 mm	95 mm	102 mm	108 mm	114 mm	121 mm
83-615-00	83-615-05	83-615-10	83-615-15	83-615-20	83-615-25	83-615-30	83-615-35	83-615-40	83-615-45	83-615-50

**7 Loch Plattenlänge: 165 mm**

**7 holes Length of plate: 165 mm**

**7 agujeros Longitud de placa: 165 mm**

**Nagellänge • Nail length • Longitud de clavo**

57 mm	63 mm	70 mm	76 mm	82 mm	89 mm	95 mm	102 mm	108 mm	114 mm	121 mm
83-620-00	83-620-05	83-620-10	83-620-15	83-620-20	83-620-25	83-620-30	83-620-35	83-620-40	83-620-45	83-620-50

**10 Loch Plattenlänge: 220 mm**

**10 holes Length of plate: 220 mm**

**10 agujeros Longitud de placa: 220 mm**

**Nagellänge • Nail length • Longitud de clavo**

57 mm	63 mm	70 mm	76 mm	82 mm	89 mm	95 mm	102 mm	108 mm	114 mm	121 mm
83-625-00	83-625-05	83-625-10	83-625-15	83-625-20	83-625-25	83-625-30	83-625-35	83-625-40	83-625-45	83-625-50

**12 Loch Plattenlänge: 260 mm**

**12 holes Length of plate: 260 mm**

**12 agujeros Longitud de placa: 260 mm**

**Nagellänge • Nail length • Longitud de clavo**

57 mm	63 mm	70 mm	76 mm	82 mm	89 mm	95 mm	102 mm	108 mm	114 mm	121 mm
83-630-00	83-630-05	83-630-10	83-630-15	83-630-20	83-630-25	83-630-30	83-630-35	83-630-40	83-630-45	83-630-50

**Instrumentarium für Jewett Platten  
Instrumentation for Jewett Plate  
Instrumentario para Placas de Jewett**



83-595-00    Einschläger Ausschläger  
Impactor Extractor  
Impactor Extractor

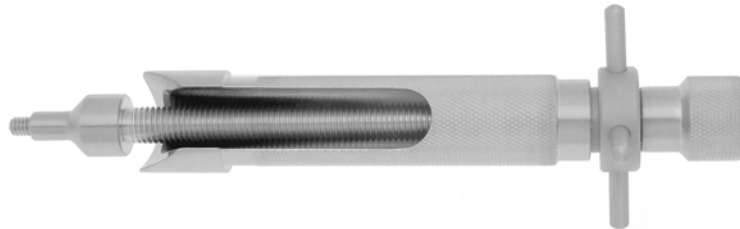

83-645-00    Einschläger Ausschläger  
Impactor Extractor  
Impactor Extractor



83-585-00    Einschläger  
Nailstarter  
Impactor Guia

**Großfragmentsortiment**  
**Set of large fragments**  
**Sortimento de grandes fragmentos**

---

**Winkelplatten 130°**  
**Angled Blade Plates 130°**  
**Placa petrocantera 130°**



**Profil:**  
**Dicke:** 5,6 mm  
**Breite:** 16,0 mm  
**Lochabstand:** 16,0 mm  
**Klinge U - Profil:** 6,5 mm x 16 mm

4 Loch • 4 Holes • 4 agujeros

Art. Nr Cat. No. Cat. No.	Klingenlänge Length of Blade Longitud de lamina	Art. Nr Cat. No. Cat. No.	Klingenlänge Length of Blade Longitud de lamina
83-660-00	50 mm	83-660-12	90 mm
83-660-02	60 mm	83-660-14	95 mm
83-660-04	70 mm	83-660-16	100 mm
83-660-06	75 mm	83-660-18	105 mm
83-660-08	80 mm	83-660-20	110 mm
83-660-10	85 mm		

6 Loch • 6 Holes • 6 agujeros

Art. Nr Cat. No. Cat. No.	Klingenlänge Length of Blade Longitud de lamina	Art. Nr Cat. No. Cat. No.	Klingenlänge Length of Blade Longitud de lamina
83-665-00	50 mm	83-665-06	80 mm
83-665-02	60 mm	83-665-08	90 mm
83-665-04	70 mm		

9 Loch • 9 Holes • 9 agujeros

Art. Nr Cat. No. Cat. No.	Klingenlänge Length of Blade Longitud de lamina
83-670-00	70 mm
83-670-02	80 mm
83-670-04	90 mm

12 Loch • 12 Holes • 12 agujeros

Art. Nr Cat. No. Cat. No.	Klingenlänge Length of Blade Longitud de lamina
83-675-00	70 mm
83-675-02	80 mm
83-675-04	90 mm

**Kondylenplatten 95°  
Condylar Plates 95°  
Placas condilares 95°**

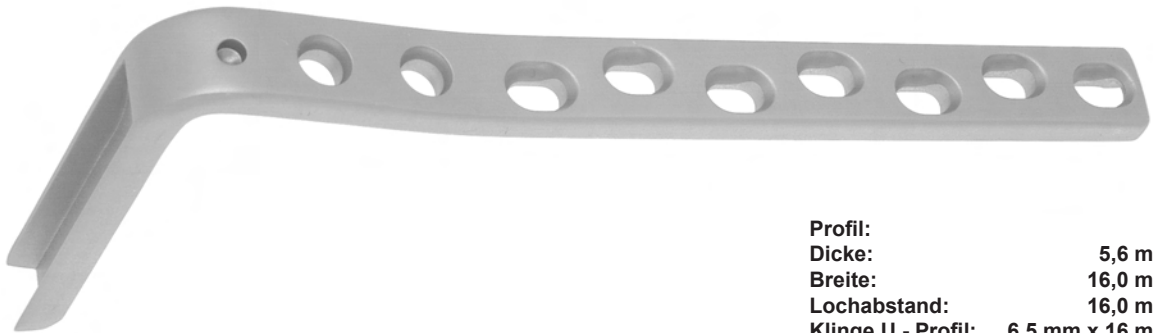

**Profil:**  
**Dicke:** 5,6 mm  
**Breite:** 16,0 mm  
**Lochabstand:** 16,0 mm  
**Klinge U - Profil:** 6,5 mm x 16 mm

5 Loch • 5 Holes • 5 agujeros

Art. Nr Cat. No. Cat. No.	Klingenlänge Length of Blade Longitud de lamina
83-680-00	50 mm
83-680-02	60 mm
83-680-04	70 mm
83-680-06	80 mm

7 Loch • 7 Holes • 7 agujeros

Art. Nr Cat. No. Cat. No.	Klingenlänge Length of Blade Longitud de lamina
83-685-00	50 mm
83-685-02	60 mm
83-685-04	70 mm
83-685-06	80 mm

9 Loch • 9 Holes • 9 agujeros

Art. Nr Cat. No. Cat. No.	Klingenlänge Length of Blade Longitud de lamina
83-690-00	50 mm
83-690-02	60 mm
83-690-04	70 mm
83-690-06	80 mm

12 Loch • 12 Holes • 12 agujeros

Art. Nr Cat. No. Cat. No.	Klingenlänge Length of Blade Longitud de lamina
83-695-00	50 mm
83-695-02	60 mm
83-695-04	70 mm
83-695-06	80 mm

**Instrumente für Winkel - und Kondylenplatten**  
**Instruments for Angled Blade - and Condylar Plates**  
**Instrumentos para placas petrocanteras y placas condilares**

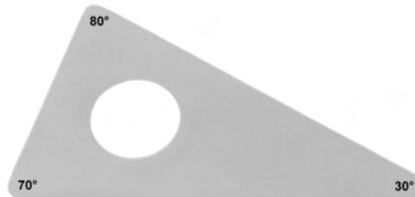

83-700-00 Dreieckige Positionierplatte 80°/70°/30°  
Triangular Positioning Plate 80°/70°/30°  
Placa triangular para posicionar 80°/70°/30°

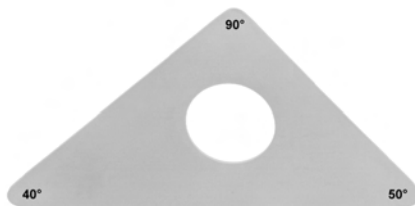

83-700-02 Dreieckige Positionierplatte 90°/50°/40°  
Triangular Positioning Plate 90°/50°/40°  
Placa triangular para posicionar 90°/50°/40°



83-700-04 Dreieckige Positionierplatte 100°/60°/20°  
Triangular Positioning Plate 100°/60°/20°  
Placa triangular para posicionar 100°/60°/20°



**Instrumente für Winkel - und Kondylenplatten**  
**Instruments for Angled Blade - and Condylar Plates**  
**Instrumentos para placas petrocantadas y placas condilares**



83-700-10 Zielplatte für Varisationsosteotomie 80°/70°/30°  
Quadrangular Positioning Plate 80°/70°/30°  
Placa cuadrada para posicionar 80°/70°/30°



83-705-00 Kondylenzielgerät  
Condylar Plate Guide  
Plantilla para placas condilares

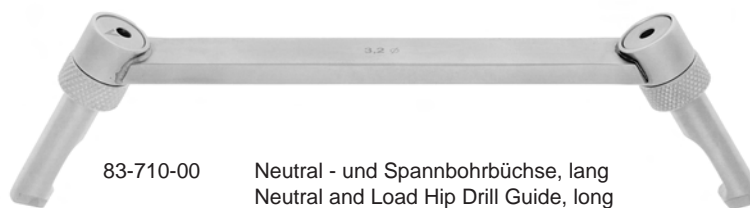

83-710-00 Neutral - und Spannböhrbüchse, lang  
Neutral and Load Hip Drill Guide, long  
Guía de broca neutral y para tensión, larga

**Instrumente für Winkel - und Kondylenplatten**  
**Instruments for Angled Blade - and Condylar Plates**  
**Instrumentos para placas pertrcanteras y placas condilares**



83-715-00 Dreifache Bohrbüchse gewinkelt 130°  
Triple Drill Guide fixed angle 130°  
Guia triple con visor 130°



83-720-00 Bohrbüchse für Platten mit Rundlöcher 60 mm lang  
Drill Guide for round hole Plates, 60 mm long  
Guia de broca para placas con agujeros redondos, 60 mm de largo



83-725-00 Kopfraumfräser mit AO Schaft Zapfen 3,2 mm  
Reamer with end for quick coupling tip 3,2 mm  
Fresa con mango para acoplamiento rapido punta 3,2 mm



83-730-00 Führungsplatte mit verstellbarem Winkel  
Chisel Guide with adjustable angle  
Controlador de angulos para escoplos

**Instrumente für Winkel - und Kondylenplatten**  
**Instruments for Angled Blade - and Condylar Plates**  
**Instrumentos para placas pertrcanteras y placas condilares**



83-735-00 Ein - und Ausschlaginstrument für Winkelplatte  
Inserter Extractor  
Impactor Extractor de angulo variable



83-740-00 Plattensitzinstrument  
Seating Chisel  
Escoplo - guia graduada

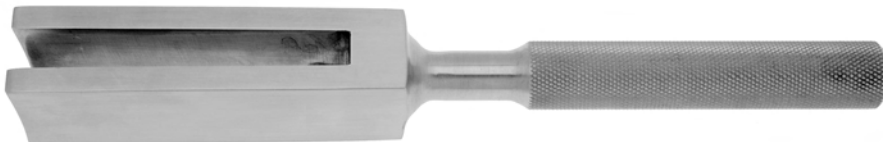

80-450-00 Schlitzhammer  
Slotted Hammer  
Martillo diapason



83-750-00 Nachschlagbolzen  
Impactor  
Impactor

# Großfragmentsortiment

## Set of large fragments

### Sortimento de grandes fragmentos

---

#### Grundinstrumentarium Basic Instrumentarium Instrumentario general



- 83-820-00 Spiralbohrer ø 3,2 mm Anschluss für Schnellkupplung 145 mm lang  
Drill Bit ø 3,2 mm with AO Shaft 145 long  
Broca ø 3,2 mm para acoplamiento rapido 145 largo
- 83-820-05 Spiralbohrer ø 3,2 mm Anschluss für Schnellkupplung 195 mm lang  
Drill Bit ø 3,2 mm with AO Shaft 195 long  
Broca ø 3,2 mm para acoplamiento rapido 195 largo



- 83-825-00 Spiralbohrer ø 3,2 mm Rundschaft 145 mm lang  
Drill Bit ø 3,2 mm round Shaft 145 long  
Broca ø 3,2 mm vastago redondo 145 largo
- 83-825-05 Spiralbohrer ø 3,2 mm Rundschaft 195 mm lang  
Drill Bit ø 3,2 mm round Shaft 195 long  
Broca ø 3,2 mm vastago redondo 195 largo



- 83-830-00 Spiralbohrer ø 4,5 mm Anschluss für Schnellkupplung 145 mm lang  
Drill Bit ø 4,5 mm with AO Shaft 145 long  
Broca ø 4,5 mm para acoplamiento rapido 145 largo
- 83-830-05 Spiralbohrer ø 4,5 mm Anschluss für Schnellkupplung 195 mm lang  
Drill Bit ø 4,5 mm with AO Shaft 195 long  
Broca ø 4,5 mm para acoplamiento rapido 195 largo



- 83-835-00 Spiralbohrer ø 4,5 mm Rundschaft 145 mm lang  
Drill Bit ø 4,5 mm round Shaft 145 long  
Broca ø 4,5 mm vastago redondo 145 largo
- 83-835-05 Spiralbohrer ø 4,5 mm Rundschaft 195 mm lang  
Drill Bit ø 4,5 mm round Shaft 195 long  
Broca ø 4,5 mm vastago redondo 195 largo

**Grundinstrumentarium  
Basic Instrumentarium  
Instrumentario general**



- 83-840-00     $\varnothing$  4,5 mm Gewindeschneider, 110 mm lang, kurzes Gewinde  
Tap  $\varnothing$  4,5 mm, 110 mm long, short threaded  
Macho  $\varnothing$  4,5 mm, longitud 110 mm, rosca corta



- 83-845-00    Gewindeschneider  $\varnothing$  4,5 mm, 70 mm lang, langes Gewinde  
Tap  $\varnothing$  4,5 mm, 70 mm long, long threaded  
Macho  $\varnothing$  4,5 mm, longitud 70 mm, rosca larga



- 83-845-05    Gewindeschneider  $\varnothing$  4,5 mm, 70 mm lang, langes Gewinde mit T - Griff  
Tap  $\varnothing$  4,5 mm, 70 mm long, long threaded with T - Bar  
Macho  $\varnothing$  4,5 mm, longitud 70 mm, rosca larga con mango en T

- 83-850-05    Gewindeschneider  $\varnothing$  6,5 mm mit T- Griff  
Tap  $\varnothing$  6,5 mm with T - Bar  
Macho  $\varnothing$  6,5 mm con mango en T



- 83-850-00    Gewindeschneider  $\varnothing$  6,5 mm  
Tap  $\varnothing$  6,5 mm  
Macho  $\varnothing$  6,5 mm

**Großfragmentsortiment**  
**Set of large fragments**  
**Sortimento de grandes fragmentos**

---

**Grundinstrumentarium**  
**Basic Instrumentarium**  
**Instrumentario general**

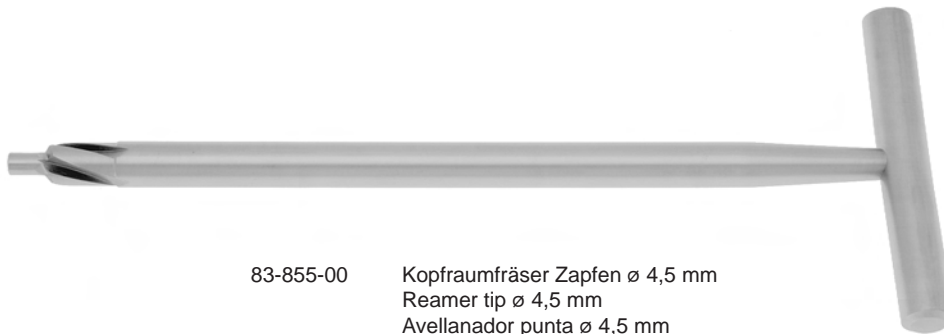

83-855-00 Kopfraumfräser Zapfen  $\varnothing$  4,5 mm  
Reamer tip  $\varnothing$  4,5 mm  
Avellanador punta  $\varnothing$  4,5 mm



83-860-00 Griffstück für Gewindeschneider mit Schnellkupplung  
Handle for taps with quick coupling  
Mandril para machos de acoplamiento rapido



83-860-05 Griffstück  
Handle  
Mandril

**Grundinstrumentarium  
Basic Instrumentarium  
Instrumentario general**

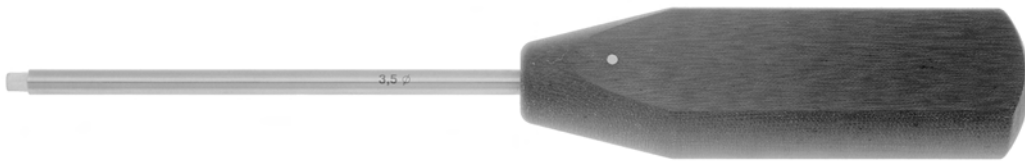

83-870-00 Schraubenzieher 6 - kant 3,5 mm SW  
Hexagonal screw driver width across flats 3,5 mm  
Destornillador hexagonal 3,5 mm



83-875-00 Schraubenziehereinsatz 6 - kant 3,5 mm SW  
Hexagonal Screwdriver for quick coupling 3,5 mm  
Destornillador para acoplamiento rapido 3,5 mm



83-880-00 Schraubenmeßgerät für große Schrauben  
Depth Gauge for 4,5 mm and 6,5 mm screws  
Medidor de profundidad para tornillos de 4,5 mm y 6,5 mm



81-380-00 Scharfer Haken  
Sharp Hook  
Gancho agudo

Großfragmentsortiment  
Set of large fragments  
Sortimento de grandes fragmentos

---

**Grundinstrumentarium  
Basic Instrumentarium  
Instrumentario general**



83-900-00 Doppelbohrbüchse 6,5 / 3,2 mm  
Drill Sleeve 6,5 mm / 3,2 mm  
Guia de broca 6,5 mm / 3,2 mm



83-905-00 Doppelbohrbüchse 4,5 / 3,2 mm  
Drill Sleeve 4,5 mm / 3,2 mm  
Guia de broca 4,5 mm / 3,2 mm



83-910-00 Geweschutzhülse ø 3,5 mm  
Drill Guide ø 3,5 mm  
Guia de broca ø 3,5 mm



83-915-00 Bohrbüchse für Halbrohrplatten und Formplatten ø 3,2 mm  
Drill Guide for Semi Tubular Plates and Formed Plates 3,2 mm  
Guia de broca para placas semitubulares y placas en formas especiales ø 3,2 mm



**Grundinstrumentarium  
Basic Instrumentarium  
Instrumentario general**

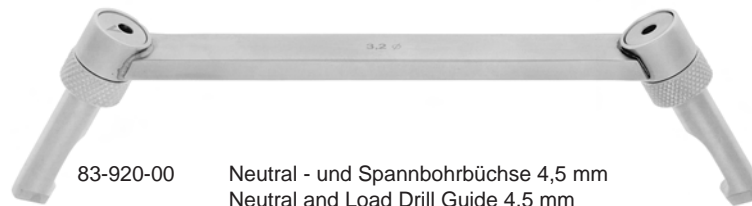

83-920-00 Neutral - und Spannbohrbüchse 4,5 mm  
Neutral and Load Drill Guide 4,5 mm  
Guia de broca neutral y para tension 4,5 mm



83-925-00 Gewebeschutzhülse für Bohrer  $\varnothing$  4,5 mm  
Tap Sleeve for drill bit  $\varnothing$  4,5 mm  
Guia dentada con casquillo  $\varnothing$  4,5 mm



83-930-00 Zielgerät mit Spitze  
Pointed Drill Guide  
Centrador de perforacion fijo



83-935-00 Steck - Bohrbüchse für Bohrer  $\varnothing$  3,2 mm  
Insert Drill Sleeve for drill bit  $\varnothing$  3,2 mm  
Casquillo centradores

**Großfragmentsortiment**  
**Set of large fragments**  
**Sortimento de grandes fragmentos**

---

**Grundinstrumentarium**  
**Basic Instrumentarium**  
**Instrumentario general**



83-940-00 Bohrlehre für Plattenspanner  
Drill Sleeve for Tension Device  
Guia de perforacion para tensor

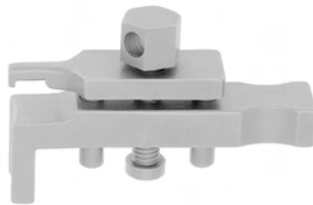

83-945-00 Plattenspanner Spannweg 8 mm  
8 mm screw - type Compression  
Tensor de placas carrera 8 mm

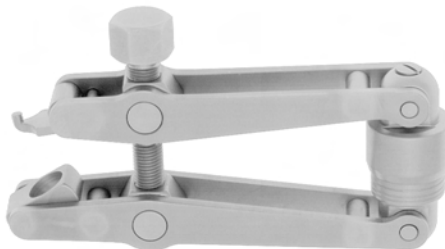

83-945-05 Plattenspanner mit Gelenken Spannweg 20 mm  
Articulated Tension Device with indicator span 20 mm  
Tensor de placas carrera 20 mm con charnela

**Grundinstrumentarium  
Basic Instrumentarium  
Instrumentario general**



83-950-00 Kardanschlüssel 11 mm SW  
Socket Wrench width across flats 11 mm  
Llave cardan de 11 mm



83-955-00 Gabelschlüssel 11 mm SW  
Combination Wrench width across flats 11 mm  
Llave de 11 mm



83-960-00 Stiftschlüssel  
Pin Wrench  
Palanca para tensor



81-720-00 Selbsthaltende Schraubenpinzette  
Screw Forceps selfholding  
Pinza fijadora

Großfragmentsortiment  
 Set of large fragments  
 Sortimento de grandes fragmentos

---

Grundinstrumentarium  
 Basic Instrumentarium  
 Instrumentario general



Biegeschablone  
 Bending Template  
 Schablon para doblar

Art. Nr.	Löcher
Cat. No.	Holes
Cat. No.	Agujeros
83-970-00	5
83-970-02	7
83-970-04	9

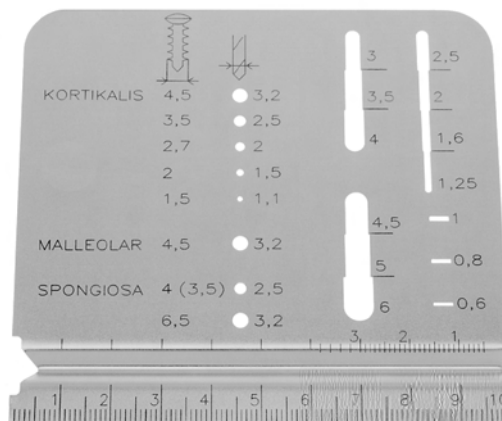

81-710-00 Messlehre für Schrauben  
 Measuring Plate for screws  
 Medidor para tornillos

Grundinstrumentarium  
Basic Instrumentarium  
Instrumentario general



83-980-00    Schränkeisen 4 / 6 mm  
Bending Iron 4 / 6 mm  
Llave dobladora 4 / 6 mm



83-990-00    Biegepresse  
Bending Device  
Prensa dobladora

**Großfragmentsortiment**  
**Set of large fragments**  
**Sortimento de grandes fragmentos**

---

**Kannulierte Schrauben  
Cannulated Screws  
Tornillos canulados**

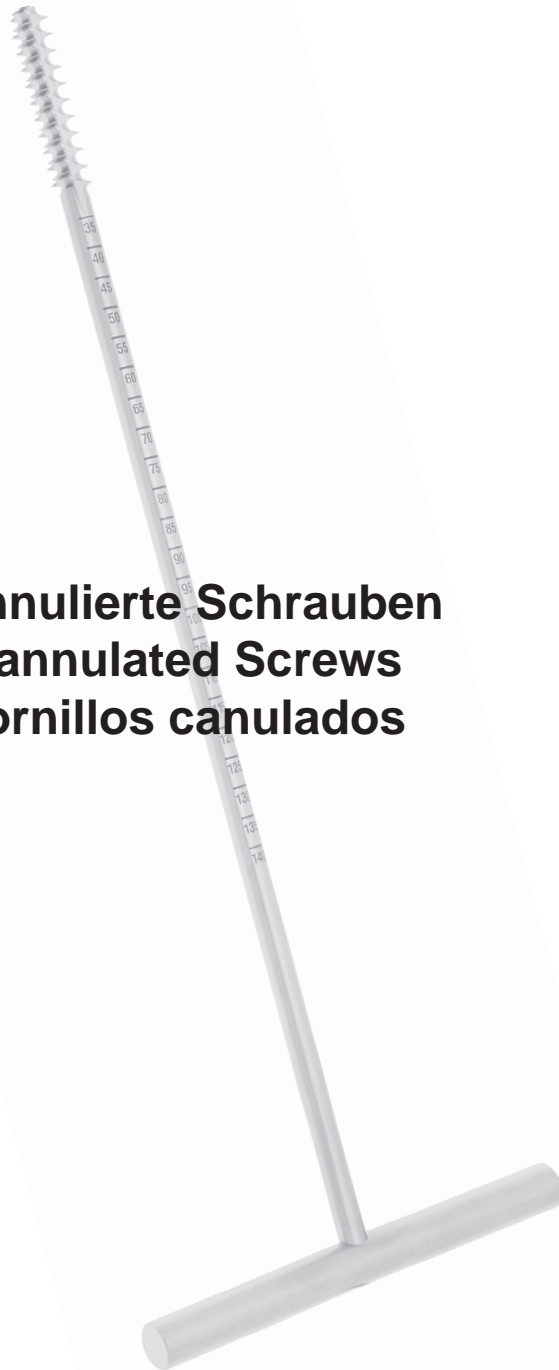

# Hohlschrauben

## Cannulated screws

### Tornillos canulados

---

#### Hohlschraubensystem

#### Cannulated Screws

#### Tornillos canulados



Hohlschraube,  $\varnothing$  7,0 mm, Innensechskant 5,0 mm, Gewindelänge 16 mm  
Cannulated Screw,  $\varnothing$  7,0 mm, Imbus 5,0 mm, Length of thread 16 mm  
Tornillo canulado,  $\varnothing$  7,0 mm, Hexagono interior 5,0 mm, Longitud de rosca 16 mm



Hohlschraube,  $\varnothing$  7,0 mm, Innensechskant 5,0 mm, Gewindelänge 32 mm  
Cannulated Screw,  $\varnothing$  7,0 mm, Imbus 5,0 mm, Length of thread 32 mm  
Tornillo canulado,  $\varnothing$  7,0 mm, Hexagono interior 5,0 mm, Longitud de rosca 32 mm



Hohlschraube,  $\varnothing$  4,0 mm, Innensechskant 2,5 mm  
Cannulated Screw,  $\varnothing$  7,0 mm, Imbus 2,5 mm  
Tornillo canulado,  $\varnothing$  7,0 mm, Hexagono interior 2,5 mm



Hohlschraube,  $\varnothing$  4,5 mm, Innensechskant 3,5 mm  
Cannulated Screw,  $\varnothing$  4,5 mm, Imbus 3,5 mm  
Tornillo canulado,  $\varnothing$  4,5 mm, Hexagono interior 3,5 mm



**Hohlschraubensystem**  
**Cannulated Screws**  
**Tornillos canulados**

Hohlschrauben 7 mm Gewindelänge 16 mm  
Cannulated Screws 7 mm Length of thread 16 mm  
Tornillos canulados 7 mm longitud de rosca 16 mm

Art. Nr. Cat. No. Cat. No.	Länge Length Longitud
85-100-00	25 mm
85-100-02	30 mm
85-100-04	35 mm
85-100-06	40 mm
85-100-08	45 mm
85-100-10	50 mm
85-100-12	55 mm
85-100-14	60 mm
85-100-16	65 mm
85-100-18	70 mm
85-100-20	75 mm
85-100-22	80 mm
85-100-24	85 mm
85-100-26	90 mm
85-100-28	95 mm
85-100-30	100 mm
85-100-32	105 mm
85-100-34	110 mm
85-100-36	115 mm
85-100-38	120 mm

Hohlschrauben 7 mm Gewindelänge 32 mm  
Cannulated Screws 7 mm Length of thread 32 mm  
Tornillos canulados 7 mm longitud de rosca 32 mm

Art. Nr. Cat. No. Cat. No.	Länge Length Longitud
85-110-00	40 mm
85-110-02	45 mm
85-110-04	50 mm
85-110-06	55 mm
85-110-08	60 mm
85-110-10	65 mm
85-110-12	70 mm
85-110-14	75 mm
85-110-16	80 mm
85-110-18	85 mm
85-110-20	90 mm
85-110-22	95 mm
85-110-24	100 mm
85-110-26	105 mm
85-110-28	110 mm
85-110-30	115 mm
85-110-32	120 mm

Hohlschrauben 4,0 mm  
Cannulated Screws 4,0 mm  
Tornillos canulados 4,0 mm

Art. Nr. Cat. No. Cat. No.	Länge Length Longitud
85-120-00	10 mm
85-120-02	12 mm
85-120-04	14 mm
85-120-06	16 mm
85-120-08	18 mm
85-120-10	20 mm
85-120-12	22 mm
85-120-14	24 mm
85-120-16	26 mm
85-120-18	28 mm
85-120-20	30 mm

Hohlschrauben 4,5 mm  
Cannulated Screws 4,5 mm  
Tornillos canulados 4,5 mm

Art. Nr. Cat. No. Cat. No.	Länge Length Longitud
85-130-00	25 mm
85-130-02	30 mm
85-130-04	35 mm
85-130-06	40 mm
85-130-08	45 mm
85-130-10	50 mm
85-130-12	55 mm
85-130-14	60 mm

**Hohlschraubensystem - Instrumente**  
**Instruments for cannulated Screws**  
**Instrumentos para tornillos canulados**



85-140-00 Bohrer durchgebohrt  $\varnothing$  5,0 mm  
Drill Bit canulated  $\varnothing$  5,0 mm  
Broca canulada  $\varnothing$  5,0 mm



85-150-00 Kortikalis Senker durchbohrt  $\varnothing$  4,5 mm  
Cortex Reamer canulated  $\varnothing$  4,5 mm  
Avellandor canulado  $\varnothing$  4,5 mm

85-150-10 Kortikalis Senker durchbohrt  $\varnothing$  7,0 mm  
Cortex Reamer canulated  $\varnothing$  7,0 mm  
Avellandor canulado  $\varnothing$  7,0 mm



85-160-00 Bohrer durchgebohrt  $\varnothing$  5,0 mm  
Drill Bit canulated  $\varnothing$  5,0 mm  
Broca canulada  $\varnothing$  5,0 mm

Hohlschraubensystem - Instrumente  
Instruments for cannulated Screws  
Instrumentos para tornillos canulados



85-170-00 Gewindeschneider ø 4,5 mm  
Tap ø 4,5 mm  
Macho ø 4,5 mm

85-170-10 Gewindeschneider ø 7,0 mm  
Tap ø 7,0 mm  
Macho ø 7,0 mm



Schraubenzieher durchbohrt  
Screw Driver cannulated  
Destornillador canulado

85-180-00 Für 4,0 mm Schrauben  
For 4,0 mm Screws  
Para tornillos de 4,0 mm

85-180-10 Für 4,5 mm Schrauben  
For 4,5 mm Screws  
Para tornillos de 4,5 mm

85-180-20 Für 7,0 mm Schrauben  
For 7,0 mm Screws  
Para tornillos de 7,0 mm



Schraubenzieher mit T - Griff  
Screw Driver with T - Handle  
Destornillador con mango en T

85-190-00 Für 4,0 mm Schrauben  
For 4,0 mm Screws  
Para tornillos de 4,0 mm

85-190-10 Für 4,5 mm Schrauben  
For 4,5 mm Screws  
Para tornillos de 4,5 mm

85-190-20 Für 7,0 mm Schrauben  
For 7,0 mm Screws  
Para tornillos de 7,0 mm

Hohlschrauben  
Cannulated screws  
Tornillos canulados

---



85-200-00 Parallelzielgerät  
Parallel Target Device  
Centrador paralelo



85-210-00 Gewebeschutzhülse  
Tissue Protector  
Protector de tejidos

Unterlagsscheiben für Hohlschrauben  
Washer for Hollow Screws  
Arandelas para tornillos huecos



85-220-00  
ø 18,0 mm



85-220-10  
ø 15,0 mm



85-220-20  
13,0 mm

---



**Klammern  
Staples  
Grapas**

---

# Epiphysenklammern Epiphiseal Staples Grapas para epiphisis

---

## Epiphysen Klammer aus rostfreiem Stahl Epiphiseal Staples stainless Steel Grapas para epifisis de acero inoxidable



86-100-00  
24 x x33 x 4,8 mm

86-100-10  
24 x 33 x 9,5 mm

86-100-20  
24 x 33 x 14 mm



Artikel Nr.	Durchmesser	Breite	Länge
86-110-00	2,5 mm	22 mm	19 mm
86-110-10	2,5 mm	16 mm	19 mm
86-110-20	1,5 mm	22 mm	19 mm
86-110-30	1,5 mm	16 mm	19 mm

Andere Längen auf Wunsch lieferbar

Epiphysenklammern  
Epiphiseal Staples  
Grapas para epiphisis

---

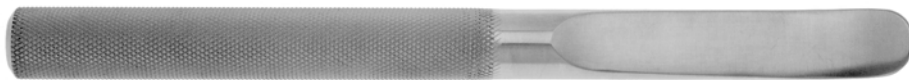

86-120-00 Klammern Entferner  
Staple Extractor  
Saca Grapas

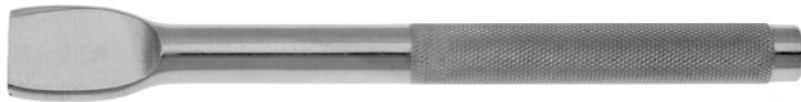

86-130-00 Klammernführer  
Staple Driver  
Conductor de grapas



86-140-00 Einschläger  
Staple Inserter  
Mete grapas

Epiphysenklammern  
Epiphiseal Staples  
Grapas para epiphisis

---



86-150-00  
6 mm

86-150-10  
8 mm

86-150-20  
11 mm

86-150-30  
14 mm

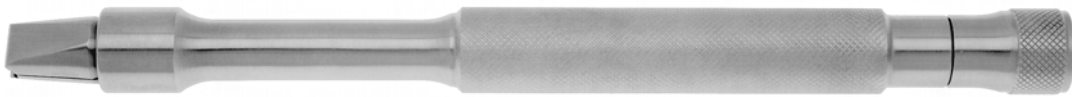

86-160-00    Einschläger  
                  Impactor  
                  Impactor





**Draht und Bügel**  
**Wire and Wire Extension Bows**  
**Alambre e Estribos**

# Draht und Bügelsortiment

## Set of wire and extension bows

### Sortimento de alambre e estribos

---

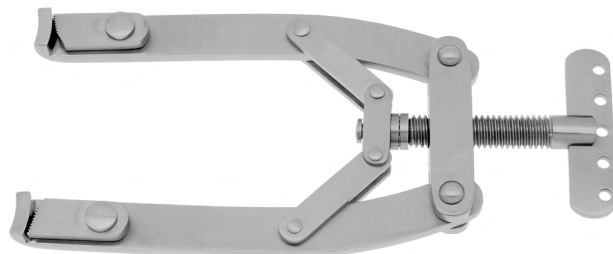

Kirschner Bügel, Amerikanisches Model  
 Kirschner Bow, American type  
 Estribo de Kirschner, modelo americano

Art. No.: Cat. No. Cat. No.:	Größe Size Tamaño	Max. Maulöffnung Max. Jaw Opening Max. Apertura de boca
87-100-00	Klein / Small / Pequeño	130 mm
87-100-10	Mittel / Medium / Mediano	185 mm
87-100-20	Groß / Large / Grande	220 mm

Kirschner Bügel  
 Kirschner Extension Bow  
 Estribo de Kirschner

Art. No.: Cat. No. Cat. No.:	Größe Size Tamaño
87-110-00	40 x 140 mm
87-110-10	60 x 220 mm



Böhler Bügel  
 Böhler Extension Bow  
 Estribo de Böhler

Art. No.: Cat. No. Cat. No.:	Innenlänge Inside Length Longitud interior	Innenbreite Inside Width Avertura interior
87-120-00	90 mm	75 mm
87-120-10	160 mm	90 mm
87-120-20	210 mm	110 mm

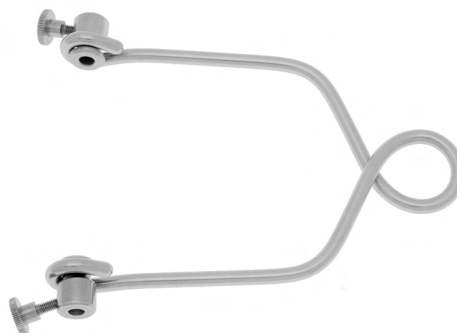

# Draht und Bügelsortiment

## Set of wire and extension bows

### Sortimento de alambre e estribos

---

Kirschner Bügel  
Kirschner Extension Bow  
Estribo de Kirschner

87-130-00	20,0 cm x 15,5 cm
87-130-05	15,5 cm x 15,5 cm
87-130-10	13,5 cm x 13,0 cm
87-130-15	12,0 cm x 12,0 cm
87-130-20	10,5 cm x 10,0 cm
87-130-25	9,5 cm x 11,0 cm
87-130-30	9,5 cm x 7,0 cm

87-140-00 Drahtspanner für Kirschner Bügel  
Wire Strainer for Kirschner Extension Bow  
Tensor para estribo de Kirschner



87-150-00 Gabelschlüssel SW 14 / 17 mm  
Screw Nut Wrench 14 / 17 mm  
Llave 14 / 17 mm

**Draht und Bügelsortiment**  
**Set of wire and extension bows**  
**Sortimento de alambre e estribos**

---

**Steimannnagel**  
**Steinmann Pin**  
**Clavo de Steinmann**



Spitze Point Punta	Trokar Trocar Trocar	Trokar Trocar Trocar	Trokar Trocar Trocar	Trokar Trocar Trocar
Schaft Shaft Vastago	Rund Round Redondo	Rund Round Redondo	Rund Round Redondo	Rund Round Redondo
Dia Length	3,5 mm	4,0 mm	4,5 mm	5,0 mm
80 mm	87-200-00	87-210-00	87-220-00	87-230-00
100 mm	87-200-02	87-210-02	87-220-02	87-230-02
120 mm	87-200-04	87-210-04	87-220-04	87-230-04
140 mm	87-200-06	87-210-06	87-220-06	87-230-06
160 mm	87-200-08	87-210-08	87-220-08	87-230-08
180 mm	87-200-10	87-210-10	87-220-10	87-230-10
200 mm	87-200-12	87-210-12	87-220-12	87-230-12
220 mm	87-200-14	87-210-14	87-220-14	87-230-14
230 mm	87-200-16	87-210-16	87-220-16	87-230-16
240 mm	87-200-18	87-210-18	87-220-18	87-230-18
260 mm	87-200-20	87-210-20	87-220-20	87-230-20
280 mm	87-200-22	87-210-22	87-220-22	87-230-22
300 mm	87-200-24	87-210-24	87-220-24	87-230-24

**Draht und Bügelsortiment**  
**Set of wire and extension bows**  
**Sortimento de alambre e estribos**

---

**Steimannnagel**  
**Steinmann Pin**  
**Clavo de Steinmann**



Spitze Point Punta	Trokar Trocar Trocar	Trokar Trocar Trocar	Trokar Trocar Trocar	Trokar Trocar Trocar
Schaft Shaft Vastago	Dreikant Triangular Triangular	Dreikant Triangular Triangular	Dreikant Triangular Triangular	Dreikant Triangular Triangular
Dia Length	3,5 mm	4,0 mm	4,5 mm	5,0 mm
80 mm	87-240-00	87-250-00	87-260-00	87-270-00
100 mm	87-240-02	87-250-02	87-260-02	87-270-02
120 mm	87-240-04	87-250-04	87-260-04	87-270-04
140 mm	87-240-06	87-250-06	87-260-06	87-270-06
160 mm	87-240-08	87-250-08	87-260-08	87-270-08
180 mm	87-240-10	87-250-10	87-260-10	87-270-10
200 mm	87-240-12	87-250-12	87-260-12	87-270-12
220 mm	87-240-14	87-250-14	87-260-14	87-270-14
230 mm	87-240-16	87-250-16	87-260-16	87-270-16
240 mm	87-240-18	87-250-18	87-260-18	87-270-18
260 mm	87-240-20	87-250-20	87-260-20	87-270-20
280 mm	87-240-22	87-250-22	87-260-22	87-270-22
300 mm	87-240-24	87-250-24	87-260-24	87-270-24

**Draht und Bügelsortiment**  
**Set of wire and extension bows**  
**Sortimento de alambre e estribos**

---

**Steimannnagel**  
**Steinmann Pin**  
**Clavo de Steinmann**



Spitze Point Punta	Trokar Trocar Trocar	Trokar Trocar Trocar	Trokar Trocar Trocar	Trokar Trocar Trocar
Schaft Shaft Vastago	Trokar Trocar Trocar	Trokar Trocar Trocar	Trokar Trocar Trocar	Trokar Trocar Trocar
Dia Length	3,5 mm	4,0 mm	4,5 mm	5,0 mm
80 mm	87-280-00	87-290-00	87-300-00	87-310-00
100 mm	87-280-02	87-290-02	87-300-02	87-310-02
120 mm	87-280-04	87-290-04	87-300-04	87-310-04
140 mm	87-280-06	87-290-06	87-300-06	87-310-06
160 mm	87-280-08	87-290-08	87-300-08	87-310-08
180 mm	87-280-10	87-290-10	87-300-10	87-310-10
200 mm	87-280-12	87-290-12	87-300-12	87-310-12
220 mm	87-280-14	87-290-14	87-300-14	87-310-14
230 mm	87-280-16	87-290-16	87-300-16	87-310-16
240 mm	87-280-18	87-290-18	87-300-18	87-310-18
260 mm	87-280-20	87-290-20	87-300-20	87-310-20
280 mm	87-280-22	87-290-22	87-300-22	87-310-22
300 mm	87-280-24	87-290-24	87-300-24	87-310-24

**Steimannnagel mit Trocar und Mittelgewinde**  
**Steinmann Pin with Trocar and central pitch**  
**Clavo de Steinmann con trocar y rosca central**



Gewindelänge: 32 mm  
Length of thread: 32 mm  
Longitud de rosca: 32 mm

Spitze Point Punta	Trocar Trocar Trocar	Trocar Trocar Trocar	Trocar Trocar Trocar	Trocar Trocar Trocar
Schaft Shaft Vastago	Dreikant Triangular Triangular	Dreikant Triangular Triangular	Dreikant Triangular Triangular	Dreikant Triangular Triangular
Dia Length	3,5 mm	4,0 mm	4,5 mm	5,0 mm
80 mm	87-320-00	87-330-00	87-340-00	87-350-00
100 mm	87-320-02	87-330-02	87-340-02	87-350-02
120 mm	87-320-04	87-330-04	87-340-04	87-350-04
140 mm	87-320-06	87-330-06	87-340-06	87-350-06
160 mm	87-320-08	87-330-08	87-340-08	87-350-08
180 mm	87-320-10	87-330-10	87-340-10	87-350-10
200 mm	87-320-12	87-330-12	87-340-12	87-350-12
220 mm	87-320-14	87-330-14	87-340-14	87-350-14
230 mm	87-320-16	87-330-16	87-340-16	87-350-16
240 mm	87-320-18	87-330-18	87-340-18	87-350-18
260 mm	87-320-20	87-330-20	87-340-20	87-350-20
280 mm	87-320-22	87-330-22	87-340-22	87-350-22
300 mm	87-320-24	87-330-24	87-340-24	87-350-24

**Draht und Bügelsortiment**  
**Set of wire and extension bows**  
**Sortimento de alambre e estribos**

---

**Schanz'sche Schraube mit Trocar und Gewinde**  
**Schanz Pin with Trocar and pitch**  
**Clavo de Schanz con trocar y rosca**



Gewindelänge: 32 mm  
 Length of thread: 32 mm  
 Longitud de rosca: 32 mm

Spitze Point Punta	Trocar Trocar Trocar	Trocar Trocar Trocar	Trocar Trocar Trocar	Trocar Trocar Trocar
Schaft Shaft Vastago	Dreikant Triangular Triangular	Dreikant Triangular Triangular	Dreikant Triangular Triangular	Dreikant Triangular Triangular
Dia Length	3,5 mm	4,0 mm	4,5 mm	5,0 mm
80 mm	87-360-00	87-370-00	87-380-00	87-390-00
100 mm	87-360-02	87-370-02	87-380-02	87-390-02
120 mm	87-360-04	87-370-04	87-380-04	87-390-04
140 mm	87-360-06	87-370-06	87-380-06	87-390-06
160 mm	87-360-08	87-370-08	87-380-08	87-390-08
180 mm	87-360-10	87-370-10	87-380-10	87-390-10
200 mm	87-360-12	87-370-12	87-380-12	87-390-12
220 mm	87-360-14	87-370-14	87-380-14	87-390-14
230 mm	87-360-16	87-370-16	87-380-16	87-390-16
240 mm	87-360-18	87-370-18	87-380-18	87-390-18
260 mm	87-360-20	87-370-20	87-380-20	87-390-20
280 mm	87-360-22	87-370-22	87-380-22	87-390-22
300 mm	87-360-24	87-370-24	87-380-24	87-390-24



**Steinmannnagel mit Vollgewinde**  
**Steinmann Pin with full thread**  
**Clavo de Steinmann con rosca entera**



Spitze Point Punta	Trokar Trocar Trocar	Trokar Trocar Trocar
Schaft Shaft Vastago	Rund Round Redondo	Dreikant Triangular Triangular
Length	230 mm	230 mm
Dia		
1,0 mm	87-400-00	87-410-00
1,5 mm	87-400-02	87-410-02
2,0 mm	87-400-04	87-410-04
2,5 mm	87-400-06	87-410-06
3,0 mm	87-400-08	87-410-08
3,5 mm	87-400-10	87-410-10
4,0 mm	87-400-12	87-410-12
4,5 mm	87-400-14	87-410-14
5,0 mm	87-400-16	87-410-16

**Draht und Bügelsortiment**  
**Set of wire and extension bows**  
**Sortimento de alambre e estribos**

---

**Kirschnerdrähte**  
**Kirschner Wires**  
**Alambre de Kirschner**



Spitze Point Punta	Trocar Trocar Trocar	Trocar Trocar Trocar	Trocar Trocar Trocar	Trocar Trocar Trocar	Trocar Trocar Trocar	Trocar Trocar Trocar	Trocar Trocar Trocar
Schaft Shaft Vastago	Rund Round Redondo	Flach Flat Plano	Rund Round Redondo	Trocar Trocar Trocar	Flach Flat Plano	Rund Round Redondo	Trocar Trocar Trocar
Length Dia	70 mm	150 mm	150 mm	150 mm	310 mm	310 mm	310 mm
0,8 mm	87-420-00	87-430-00	87-440-00	87-450-00	87-460-00	87-470-00	87-480-00
1,0 mm	87-420-02	87-430-02	87-440-02	87-450-02	87-460-02	87-470-02	87-480-02
1,2 mm	87-420-04	87-430-04	87-440-04	87-450-04	87-460-04	87-470-04	87-480-04
1,4 mm	87-420-06	87-430-06	87-440-06	87-450-06	87-460-06	87-470-06	87-480-06
1,5 mm	87-420-08	87-430-08	87-440-08	87-450-08	87-460-08	87-470-08	87-480-08
1,6 mm	87-420-10	87-430-10	87-440-10	87-450-10	87-460-10	87-470-10	87-480-10
1,7 mm	87-420-12	87-430-12	87-440-12	87-450-12	87-460-12	87-470-12	87-480-12
1,8 mm	87-420-14	87-430-14	87-440-14	87-450-14	87-460-14	87-470-14	87-480-14
2,0 mm	87-420-16	87-430-16	87-440-16	87-450-16	87-460-16	87-470-16	87-480-16
2,2 mm	87-420-18	87-430-18	87-440-18	87-450-18	87-460-18	87-470-18	87-480-18
2,5 mm	87-420-20	87-430-20	87-440-20	87-450-20	87-460-20	87-470-20	87-480-20
3,0 mm	87-420-22	87-430-22	87-440-22	87-450-22	87-460-22	87-470-22	87-480-22

Kirschnerdraht mit Gewinde spitz / rund  
Kirschner Wire with thread trocar / round  
Alambre de Kirschner con rosca trocar / redondo



Art. Nr. Cat. No Cat. No.	Durchmesser Diameter Diámetro	Länge Length Longitud	Gewindelänge Threaded Length Longitud de rosca
87-490-00	1,6 mm	150 mm	5 mm
87-490-05	1,6 mm	150 mm	15 mm
87-490-10	2,0 mm	150 mm	15 mm
87-490-15	2,0 mm	200 mm	15 mm
87-490-20	2,5 mm	200 mm	15 mm
87-490-25	2,5 mm	230 mm	20 mm
87-490-30	2,5 mm	230 mm	100 mm

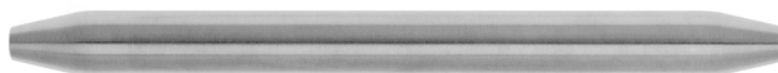

87-495-00 Biegebolzen  
Bending Iron  
Barra dobladora

# Draht und Bügelsortiment

## Set of wire and extension bows

### Sortimento de alambre e estribos



87-500-10 Parham Martin, Bandspanner  
Parham Martin, Band Tightener  
Parham Martin, tensor para cintas metalicas



87-510-00 Parham Stahl Knochenband 19,0 cm x 0,5 mm SMO  
Parham Metal Bone Band 19,0 cm x 0,5 mm SMO  
Parham cinta metalica para huesos 19 x 0,5 mm SMO



Cerclage Draht, 10 m, weich  
Cerclage Wire, 10 m, soft  
Alambre de cerclage, 10 m, blando

Cerclage Draht mit Öse, weich  
Cerclage Wire with eye, soft  
Alambre para cerclajes con ojo, blando

Art. Nr.:	Durchmesser	Gauge
Cat. No.:	Diameter	Gauge
Cat. Nr.:	Diametro	Gauge
87-520-00	0,2 mm	31
87-520-05	0,3 mm	29
87-520-10	0,4 mm	27
87-520-15	0,5 mm	25
87-520-20	0,6 mm	23
87-520-25	0,7 mm	22
87-520-30	0,8 mm	21
87-520-35	0,9 mm	20
87-520-40	1,0 mm	19
87-520-45	1,2 mm	18
87-520-50	1,5 mm	17



Cerclage Draht mit Öse, weich  
Cerclage Wire with eye, soft  
Alambre para cerclajes con ojo, blando

Art. Nr.:	Durchmesser	Länge
Cat. No.:	Diameter	Length
Cat. Nr.:	Diametro	Longitud
87-530-00	0,8 mm	280 mm
87-530-05	1,0 mm	280 mm
87-530-10	1,2 mm	280 mm
87-535-00	1,0 mm	600 mm
87-535-10	1,2 mm	600 mm

Draht und Bügelsortiment  
Set of wire and extension bows  
Sortimento de alambre e estribos

---



87-540-00 Demel, Drahtführer  
Demel, Wire Guide  
Demel, Conductor de alambre



87-550-00 Demel, Knochen Drahtspanner, 28,0 cm  
Demel, Bone Wire Tighener, 28,0 cm  
Demel, Tensdor de alambre

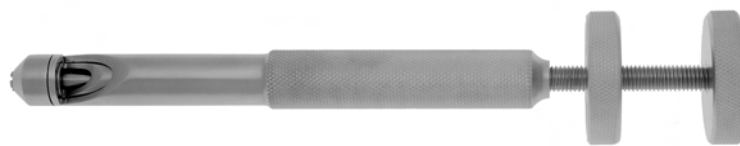

87-560-00 Loute, Knochen Drahtspanner, 22,0 cm  
Loute, Bone Wire Tighener, 22,0 cm  
Loute, tensor de alambre

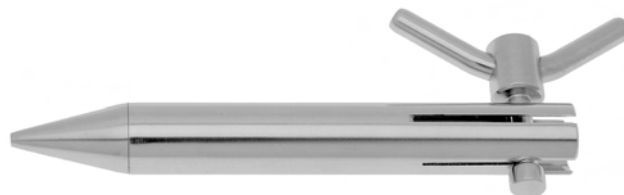

87-570-00 Drahtspanner  
Wire Tighener  
Tensor de alambre

---

**Draht und Bügelsortiment**  
**Set of wire and extension bows**  
**Sortimento de alambre e estribos**

---

---



**Zangen**  
**Forceps**  
**Tenazas**

Zangen  
Forceps  
Tenazas

---



88-100-00 Biegezange  
Bending Pliers  
Tenaza para doblar



88-110-00 Biegezange spitz  
Bending Pliers  
Tenaza para doblar



88-120-00 Biegezange  
Bending Pliers  
Tenaza para doblar



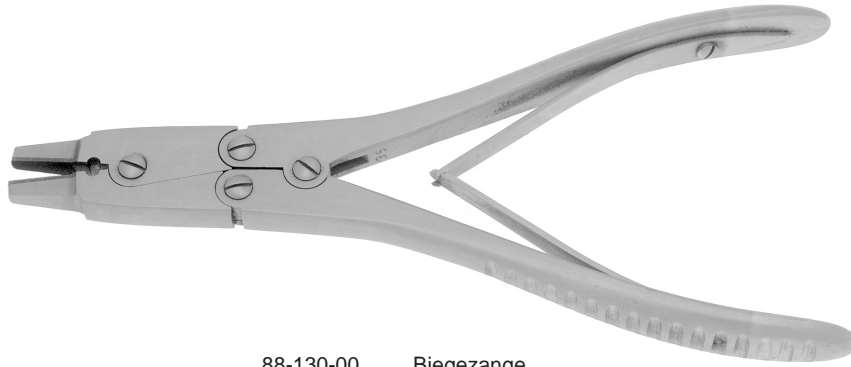

88-130-00 Biegezange  
Bending Pliers  
Tenaza para doblar



88-140-00 Gripzange  
Vise Grip  
Pinza de bloqueo



88-150-00 Biegezange  
Bending Pliers  
Tenaza para doblar

---



88-160-00 Biegezange  
Bending Pliers  
Tenaza para doblar

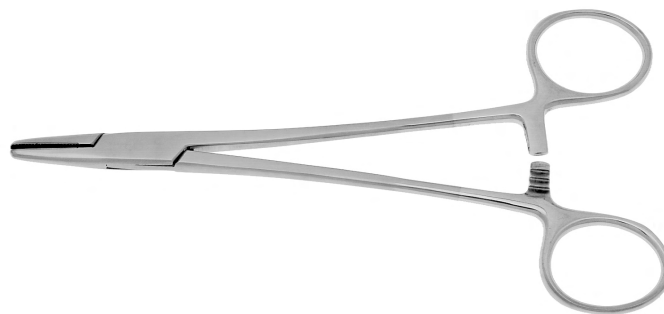

88-170-00 Draht - Biegezange  
Wire Tightening Pliers  
Tenaza para doblar alambre



88-180-00 Seitenschneider  
Wire Cutter  
Alicate



88-190-00 Seitenschneider  
Wire Cutter  
Alicate



88-200-00 Seitenschneider  
Wire Cutter  
Alicate

Zangen  
Forceps  
Tenazas

---



88-210-00 Seitenschneider, 18,0 cm  
Wire Cutter, 18,0 cm  
Alicate, 18,0 cm



88-220-00 Seitenschneider, 22,0 cm  
Wire Cutter, 22,0 cm  
Alicate, 22,0 cm



88-230-00 Seitenschneider, 14,0 cm  
Wire Cutter, 14,0 cm  
Alicate, 14,0 cm

---

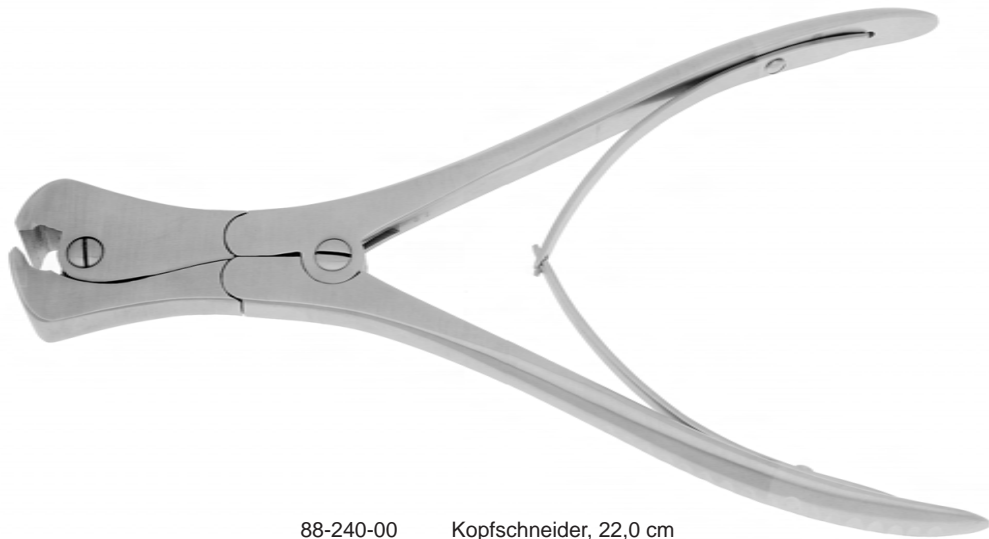

88-240-00 Kopfschneider, 22,0 cm  
Wire Cutter, 22,0 cm  
Alicate, 22,0 cm



88-250-00 Universalschere  
Universal Scissor  
Tijera universal



88-260-00 Seitenschneider für Steinmannnägel  
Wire Cutter for Steinmann Pins  
Cizalla corta clavos



---

**Bäramed**

Instrumente GmbH  
Enzianstraße 1  
72477 Schwenningen  
Tel.:07579/1730 Fax:2165  
[www.Baeramed.de](http://www.Baeramed.de)  
[info@baeramed.de](mailto:info@baeramed.de)  
[baeramed@t-online.de](mailto:baeramed@t-online.de)

Händler